



Dark Sky Compliant - Full cut off 60 Watt Norani Series comes with innovative Tunable Technology from RuggedGrade allowing you to select between 3CCT Kelvin Color & Wattage Directly on fixture.

**P/N: RGL-NORANI-120BBT4DA1-abcdeW[EM;blank]h**

Note:

RGL= RuggedGrade Lighting;

FWP05=Product series, LED Cutoff Wall Pack;

L=Product size, large;

120=Rating Power;

B=driver manufacturer;

B=lumileds led

T4= Type IV distribution;

D=LED module type, CCT adjustable;

A=Input voltage, 120-277VAC;

1=Version number;

“a” can be any two letters to represent lamp colors;

“b” can be “S” or blank for Surge-Protective Device provided or not;

“c” can be “AP” or blank for AC Photocell provided or not;

“d” can be “M”, “R”, “Z”, “ZM”, “ZP” or blank for sensor function,

“M” for Motion microwave sensor, “R” for Motion PIR sensor,

“Z” for DC Sensor Receptacle, “ZP” for DC Sensor Receptacle and

DC Motion PIR sensor, “ZM” for DC Sensor Receptacle and

DC Motion microwave sensor provided or blank for not provided;

“e” can be any digits for CCT;

“W” for wattage adjustable;

“g” can be “EM” or blank for emergency driver provided or not;

“h” can be “A” or blank for DC sensor driver provided or not;

## DIMENSIONS

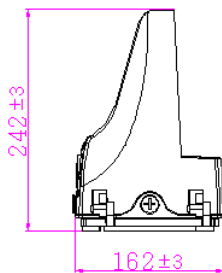
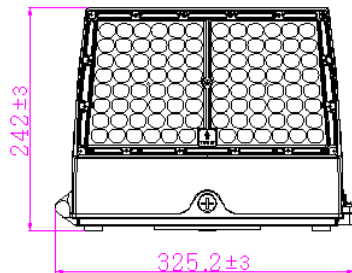
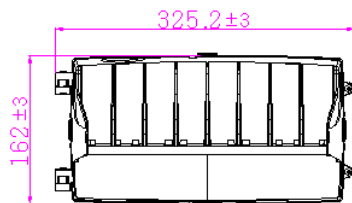

## APPLICATION

- Entrance lighting, courtyard lighting;
- Industrial lighting, Outdoor landscape lighting;
- Building, The hotel;
- Wall lighting area and so on.

## ADVANTAGE

- UL, cUL, DLC5.1 premium certificate
- Lumileds 2835, high CRI.
- Input voltage 120-277VAC .
- Output constant current lever can be adjusted through output cable with 0-10V.
- No UV or IR in the beam.
- Wattage adjustable;
- Easy to install and operate.
- Energy saving, long lifespan.
- Light is soft and uniform, safe to eyes.
- Instant start, NO flickering, NO humming.



## SPECIFICATIONS

<b>OPTICAL</b>	Input Power (Tolerance : $\pm 10\%$ )	120W (Wattage adjustable)		
	Color Temperature (Color Tunable)	3000K	4000K	5000K
	Lumen (Tolerance : -10%)	15610 lm	16710 lm	16450 lm
	Efficacy (Tolerance : -3%)	129 lm/W	143 lm/W	136 lm/w
	CRI	>80		
	Color Consistency	<7 Steps (or <7SDCM)		
	BUG	B3-U3-G2		
	Diffuser Type	PC		
	Beam Angle (50%) (Tolerance :	126*110 Degree		
<b>ELECTRICAL</b>	Input Voltage and Frequency	120-277VAC 50/60Hz		
	PF (Tolerance : -3%)	$\geq 0.9$		
	THD (Tolerance : +5%)	$\leq 20\%$		
	Flicker Percent	<30%		
	Driver Brand	RuggedGrade Lighting		
	Driver Model	RuggedGrade Driver		
	Driver Surge protection	L-N: 4kV , L&N-E: 6kV		
	Dimming	0-10V dimming standard		
	Sensor Type	Daylight Sensor, Occupancy Sensor, Multifunction Sensor, Integral Sensor Receptacle		
	Optional Accessory	Surge-protective Device, Photocell, Motion microwave Sensor, Motion PIR Sensor, Emergency, Auxiliary		
<b>MATERIALS</b>	LED Brand	LUMILEDS		
	LED Type	SMD 2835		
	LED QTY	192*2 PCS		
	Housing	Die-cast aluminum		
	Housing Color	All Color		
	Waterproof Rating	WET (IP65)		
<b>OTHERS</b>	Operating Temperature	-40°C TO 50°C, Sensor :-25°C TO 50°C, Emergency: 0°C TO 50°C		
	Storage Temperature	-40°C TO 80°C		
	Operating Humidity	20% - 90% RH		
	Storage Humidity	10% - 95% RH		
	Warranty	5 years warranty with 24/7 operating hours Luminaire lifetime at 25°C.		





**LIGHT DISTRIBUTION TESTING PARAMETERS**

## Luminaire Property

Luminaire Manufacturer:  
 Luminaire Category:  
 Lamp Catalog:  
 Number of Lamps:  
 Luminous Length (mm):  
 Luminous Height (mm):  
 Current: 1.010 A  
 Power Factor: 0.994

Luminaire Description:  
 Lamp Description:  
 Lumens per Lamp:  
 Luminous Width (mm):  
 Voltage: 120.0 V  
 Power: 120.54 W

## Photometric Results

IES Classification: Type IV  
 Total Rated Lamp Lumens: 15611.2 lm  
 Efficiency: 100%  
 Upward Ratio: 1%  
 C0r0 Intensity: 4149.12 cd  
 Pos of Max. Intensity: H135 V61

Longitudinal Classification: Short  
 Measurement Flux: 15611.2 lm  
 Downward Ratio: 99%  
 Luminaire Efficacy Rating (LER): 129.56  
 Max. Intensity: 4734.07 cd

Luminous Intensity Distribution Curve

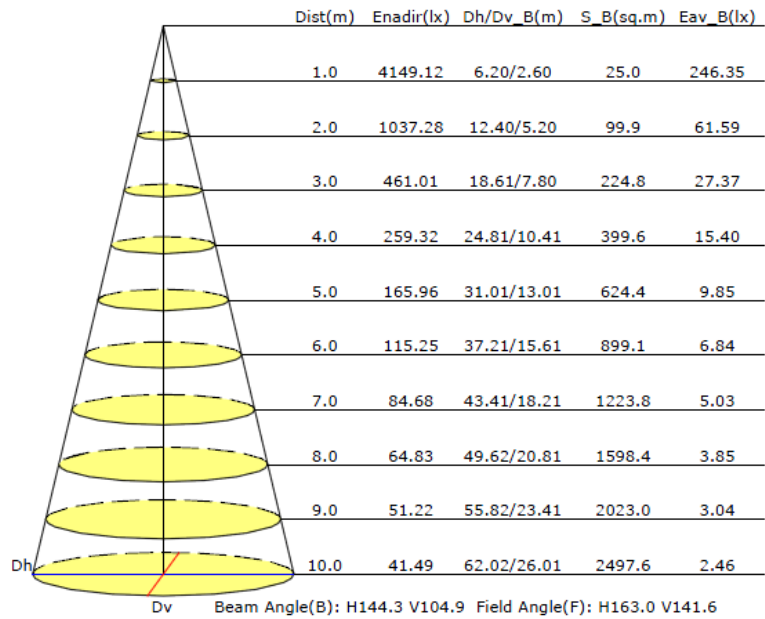
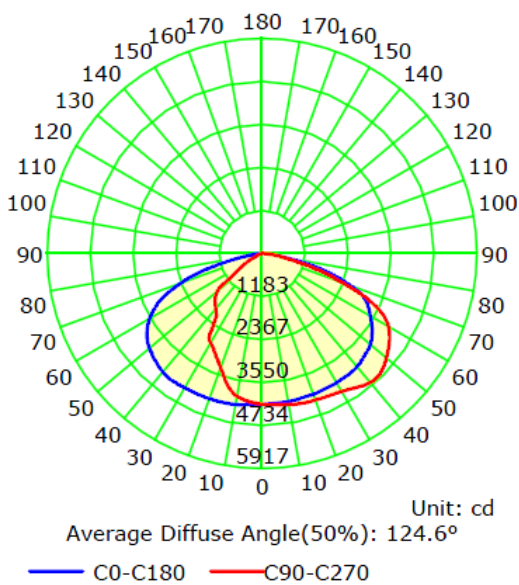

Product ID: S-Q3FOJ9



## RGL-NORANI-120BBT4DA1-abcdeW[EM;blank]h

Manufacturer: RuggedGrade  
Brand: RuggedGrade

### PRODUCT OVERVIEW

Classification	Premium
Primary Use	Outdoor Full-Cutoff Wall-Mounted Area Luminaires
Reported Input Wattage	120.5 W
Reported Light Output	15611 lm
Reported CCT	3000 K
Reported CRI (Ra)	80
Product ID	S-Q3FOJ9
DLC Family Code	SLFAJH
Listing Status	Listed
Date Qualified	2023-03-06

### PRODUCT INFORMATION

Qualified Product List	Solid State Lighting
Technical Requirements Version <sup>1</sup>	5.1
Product ID <sup>1</sup>	S-Q3FOJ9
Manufacturer <sup>1</sup>	RuggedGrade
Brand	RuggedGrade
Model Number	RGL-NORANI-120BBT4DA1-abcdeW[EM;blank]h
Parent <sup>1</sup>	No
Classification <sup>1</sup>	Premium

### PRODUCT CATEGORIZATION

[VIEW DETAILS](#)

### PRODUCT CAPABILITIES

[VIEW DETAILS](#)

### REPORTED PHOTOMETRIC PERFORMANCE

Reported Light Output <sup>1</sup>	15611 lm
Reported Efficacy (AC) <sup>1</sup>	129.51 lm/W
Reported CCT <sup>1</sup>	3000 K
Reported CRI (Ra) <sup>1</sup>	80
Reported R9 <sup>1</sup>	2
Reported IES Rf	84
Reported IES Rg	96
Reported IES Rcs,h1	-12



## PACKAGE

	Size	Qty / Carton	Net Weight / Carton	Gross Weight / Carton
Inner box	357*222*305MM	1 PC	3.6KG	4.3KG
Outer box	460*372*325MM	2 PC	7.2KG	9.4KG

Tolerance of Carton Size:  $\pm 15$  MM, Tolerance of Weight:  $\pm 10\%$ .

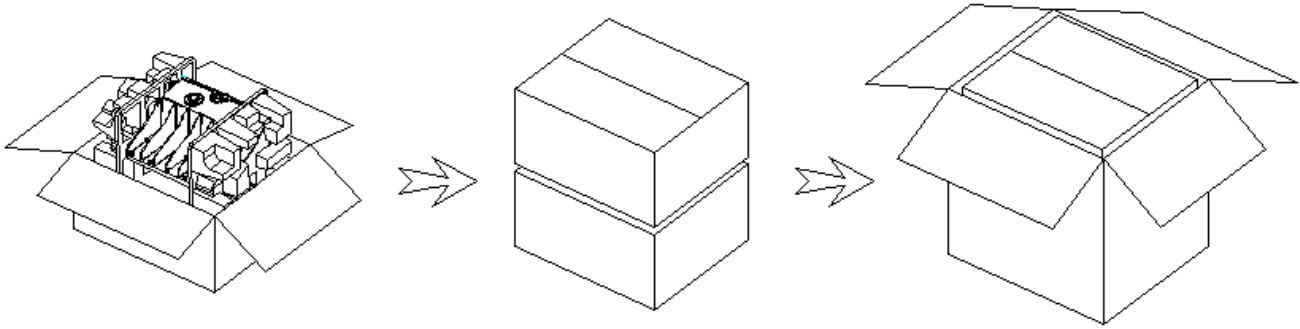

## SPECIAL FUNCTIONS INSTRUCTION:

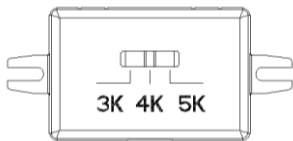

### Color tunable instruction

- 1, The color temperature of the lamp turns to 3000K when the switch is set to 3K;
- 2, The color temperature of the lamp turns to 4000K when the switch is set to 4K;
- 3, The color temperature of the lamp turns to 5000K when the switch is set to 5K;

**Note:** Please turn off the power before adjusting the color temperature.

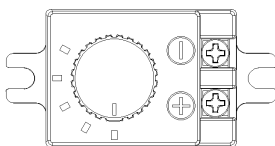

### Wattage adjustable instruction

Turn the wattage adjustable knob to a certain wattage gear, the power of the lamp will change to the corresponding wattage.

Adjustable wattage :80W,90W,100W,110W,120W;

**Note:** Please turn off the power before adjusting the wattage.

## NOTICE FOR USER

- Please turn off power before install or change assembly parts.
- The input voltage and lamps should be matched, after connecting the power line, Please make sure the wiring section is insulated.
- No-professionals, must not install and disassemble the lamps.

## TROUBLESHOOTINGS

Issue	Check points
Light Flickers	Check all wiring for disconnections, shorts and burnt wiring and connections. Confirm steady input voltage to the light fixture, fluctuating input voltage will harm the LED driver and can lead to premature failure. Lights with photocells can have photocell tag from ambient light or light reflecting back at the sensor. Simply cover the photocell completely and see if flickering continues while the photocell is covered. Call Tech Support for help if none of the above solves the issue.
Light does not work at all.	Check all wiring for disconnections, shorts and burnt wiring and connections. Confirm steady input voltage to the light fixture, fluctuating input voltage will harm the LED driver and can lead to premature failure. If input voltage is not in the voltage range of the fixture, you will need to find the source of your input voltage issue. Call Tech Support for help if none of the above solves the issue.

**For more technical information, install questions, troubleshooting help or warranty claims, we have a dedicated US Tech and Customer Support Team to help solve any issues you have and can be reached by email or phone. If you need help with any of our products, we are here for you so that you are never in the dark!**



**BETTER LIGHTS.  
BETTER SUPPORT.**



**CERTIFIED**



**LISTED**



LEGENDARY RUGGEDGRADE QUALITY  
LEGENDARY USA SUPPORT



US based  
phone and online  
customer support



ROCK SOLID  
**5 YEARS**  
WARRANTY

