

# 600W STADIUMPRO V | LED SPORT LIGHT



## PRODUCT DESCRIPTION

The StadiumPro Series reaches new heights with the Series V! It boasts enhanced efficiency, delivering an impressive 160 Lumens per watt. Equipped with top-of-the-line uPowerTek Driver, it offers versatile mounting options and advanced optics. The Stadium Pro IV is UL Listed and DLC Premium 5.1 Certification this upcoming fall, solidifying its status as the Pinnacle of sports lighting!



PART #: RGL-STADIUMPRO-5-600W

## PRODUCT FEATURES & COMMON USE APPLICATIONS

- ✓ UL cUL
- ✓ Input voltage 120-277Vac
- ✓ No UV or IR in the beam
- ✓ Easy to install and operate
- ✓ Energy saving, long lifespan
- ✓ Instant start, NO flickering, NO humming
- ✓ Green and eco-friendly without mercury
- ✓ Output constant current lever can be adjusted through output cable with 0-10V.
- ✓ Stadium Fields
- ✓ Gymnasium
- ✓ Square plaza
- ✓ Shipyard, Airport, wharf
- ✓ High mast and Contour lighting, etc.

## PRODUCT DIMENSIONS

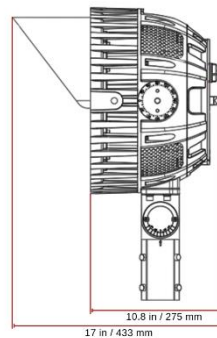
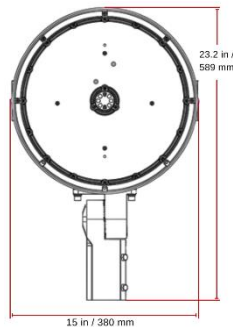
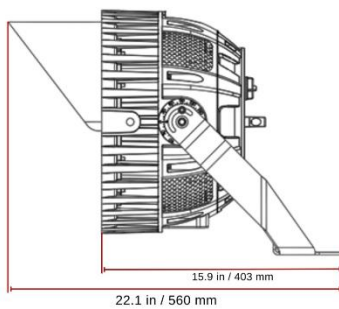
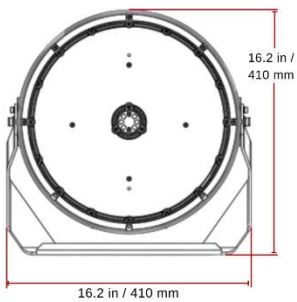

## LEGENDARY USA SUPPORT



US based phone and online customer support

DLC CERTIFIED

5 YEARS WARRANTY

UL LISTED

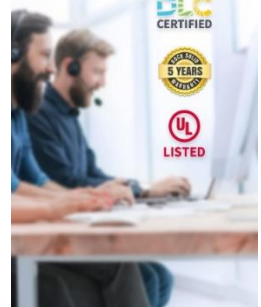

Rugged Grade Lighting  
Industrial Grade Solutions



888-953-2476  
sales@ruggedgrade.com



## PRODUCT TECHNICAL SPECIFICATIONS

<b>OPTICAL</b>	Input Power (Tolerance: $\pm 10\%$ )	600W (Wattage adjustable 25%-100%)		
	Color Temperature	4000K	5000K	5700K
	Lumen (Tolerance: -10%)	96,600 LM	97,200 LM	97,800 LM
	Efficacy (Tolerance: -3%)	161 LM/W	162 LM/W	163 LM/W
	CRI	>70		
	Color Consistency	< 6 Steps (or < 6 SDCM)		
	BUG	B5-U0-G5		
	Distribution Pattern	NEMA:4 (Optional:NEMA:4/NEMA:5)		
	Beam Angle (50%) (Tolerance: $\pm 15\%$ )	20° $\pm 3^\circ$ (Optional:(30° $\pm 5^\circ$ )/(40° $\pm 5^\circ$ ))		
<b>ELECTRICAL</b>	Input Voltage and Frequency	120-277VAC, 50/60Hz		
	PF (Tolerance: -3%)	$\geq 0.9$		
	THD (Tolerance: +5%)	$\leq 20\%$		
	Flicker Percent	<5%		
	Driver Brand	uPowerTek		
	Driver Model	BLD-600-C420-ENU		
	Driver Surge protection	L/N-PE: 10kV, L-N:6kV		
	Dimming	0-10V dimming standard		
	Optional Accessory	Sensor Receptacle+Photosensor /Sensor Receptacle+Short Cap		
<b>MATERIALS</b>	LED Brand	LUMILEDS		
	LED Type	SMD 2835		
	LED QTY	600 PCS		
	Housing	Die-cast aluminum		
	Housing Color	Black, White, Bronze, or Customized		
	EPA	1.7 ft <sup>2</sup>		
	Waterproof Rating	WET (IP65)		
	Operating Temperature	-40°C TO 45°C		
<b>OTHERS</b>	Storage Temperature	-40°C TO 80°C		
	Operating Humidity	20% - 90% RH		
	Storage Humidity	10% - 95% RH		
	Warranty	5 years warranty with 24/7 operating hours Luminaire lifetime at 25°C.		



## PRODUCT IMAGES & ACTUAL INSTALLATIONS

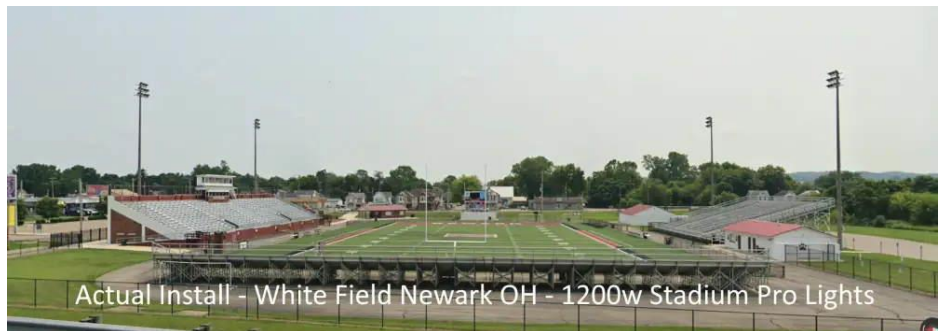
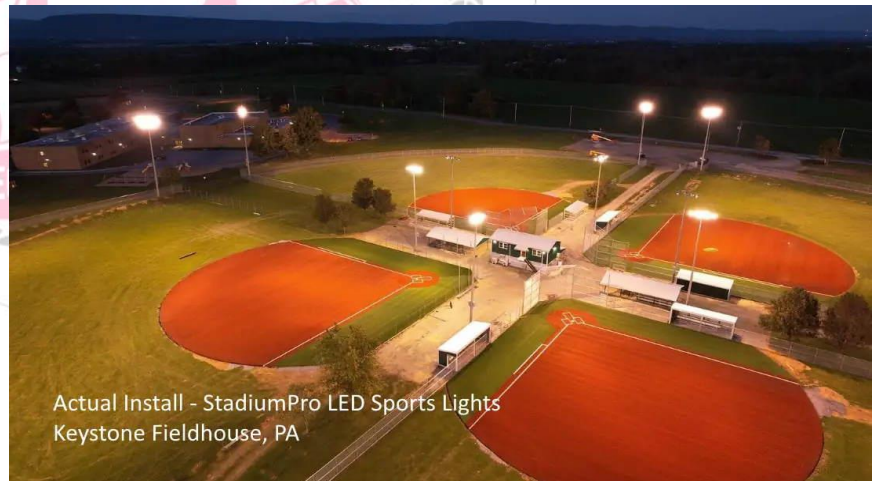
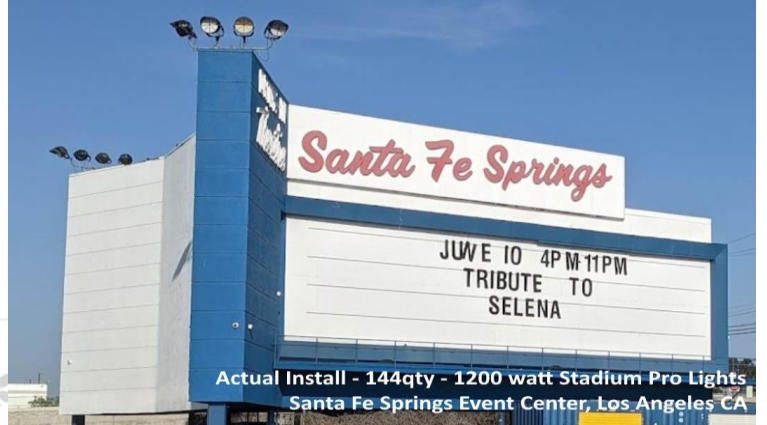

## PHOTOMETRICS

### STREETLIGHT PHOTOMETRIC TEST REPORT

Test:U:119.12V I:5.0907A P:602.11W PF:0.9929 Freq:60.01Hz  
 Lamp Flux:94897.9x1 lm

NAME :	TYPE :	WEIGHT :
SPEC. :	DIM. :	SERIAL No. :
MFR. :	SUR. :	Shielding Angle :

DATA OF LAMP		PHOTOMETRIC DATA			Eff: 157.61 lm/W
MODEL		I <sub>max</sub> (cd)	301522	η street_up (%)	0.2
NOMINAL POWER (W)	600	LOR (%)	100.0	η street_down (%)	51.5
RATED VOLTAGE (V)	120	TOTAL FLUX (lm)	94898	η house_up (%)	0.2
NOMINAL FLUX (lm)	94897.9	MAXIMUM @ (C, γ )	158,2.0	η house_down (%)	48.1
LAMPS INSIDE	1	η up (%)	0.4	76 FLASHAREA (m2)	
TEST VOLTAGE (V)	120	η down (%)	99.6	SLI	

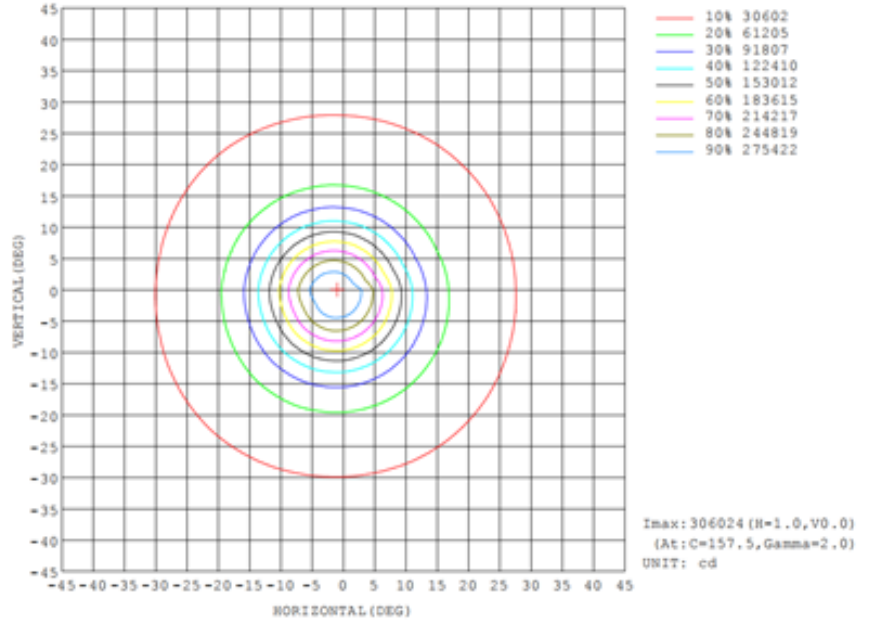
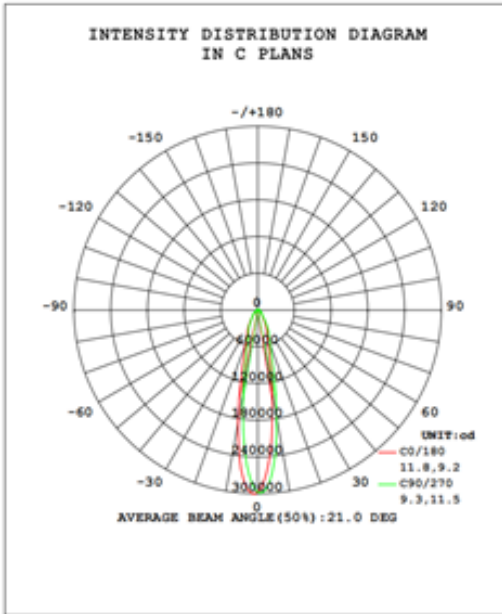

## PRODUCT PACKAGING

Bracket Type	Carton Size	Qty / Carton	Net Weight / Carton	Gross Weight / Carton
FM	600*480*370mm [23.62*18.90*14.57inch]	1 PC	15.7KG [34.61LBS]	18.2KG [40.12LBS]
AM	600*480*370mm [23.62*18.90*14.57inch]	1 PC	15.7KG [34.61LBS]	18.2KG [40.12LBS]

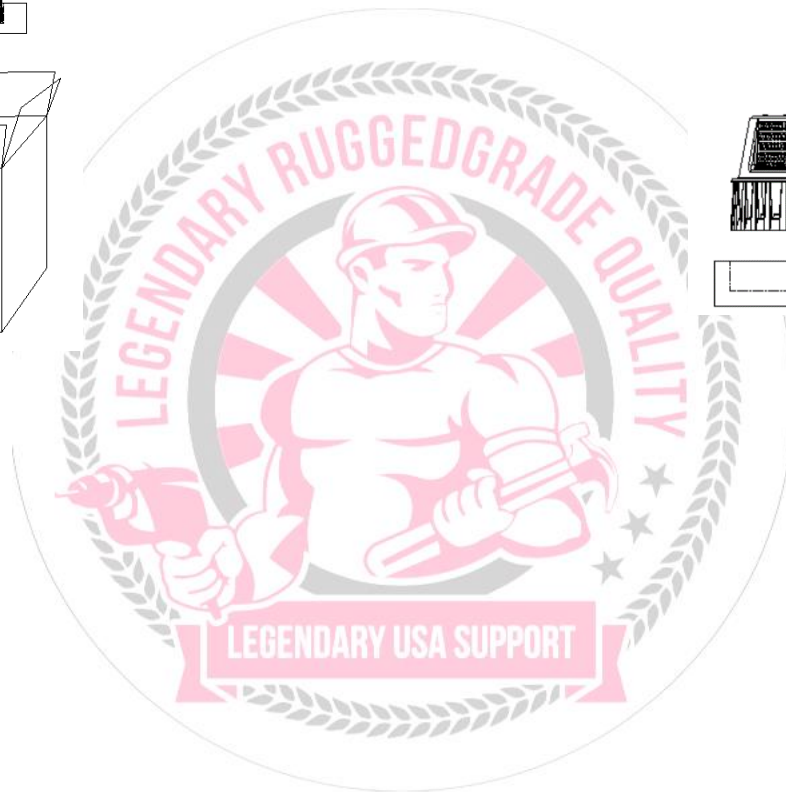
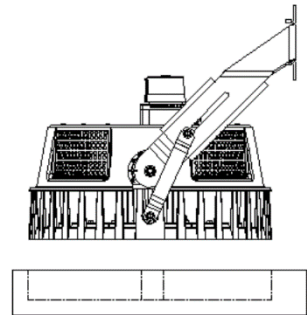
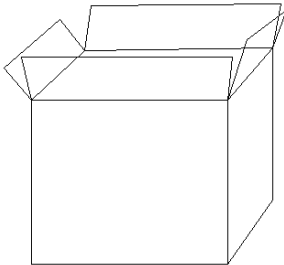
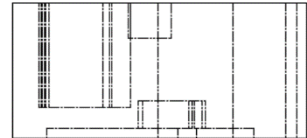
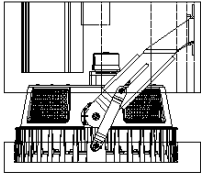

## PRODUCT WARNINGS

- ⚡ Please turn off power before install or change assembly parts.
- ⚡ The input voltage and lamps should be matched, after connecting the power line.
- ⚡ Please make sure the wiring section is insulated.
- ⚡ Professionals must install and disassemble the lamps.
- ⚡ Surge is the number 1 cause of LED light failure. Outdoor lights must have surge at fixture, pole, and breaker.
- ⚡ Surge is the number 1 cause of LED light failure. Indoor lights must have surge at fixture and breaker.

## PRODUCT TROUBLESHOOTING

Issue	Check points
Light Flickers	Check all wiring for disconnections, shorts and burnt wiring and connections. Confirm steady input voltage to the light fixture, fluctuating input voltage will harm the LED driver and can lead to premature failure. Lights with photocells can have photocell tag from ambient light or light reflecting at the sensor. Simply cover the photocell completely and see if flickering continues while the photocell is covered. Call Tech Support for help if none of the above solves the issue.
Light does not work at all.	Check all wiring for disconnections, shorts and burnt wiring and connections. Confirm steady input voltage to the light fixture, fluctuating input voltage will harm the LED driver and can lead to premature failure. If input voltage is not in the voltage range of the fixture, you will need to find the source of your input voltage issue. Call Tech Support for help if none of the above solves the issue.

For more technical information, install questions, troubleshooting help or warranty claims, we have a dedicated US Tech and Customer Support Team to help solve any issues you have and can be reached by email or phone. If you need help with any of our products, we are here for you so that you are never in the dark!

# BETTER LIGHTS. BETTER SUPPORT.

