

1400W STADIUMPRO V | LED SPORT LIGHT



PRODUCT DESCRIPTION

The StadiumPro Series reaches new heights with the Series V! It boasts enhanced efficiency, delivering an impressive 150 Lumens per watt. Equipped with top-of-the-line uPowerTek Driver, it offers versatile mounting options and advanced optics. The Stadium Pro V is UL Certified, solidifying its status as the Pinnacle of sports lighting!



PART #: RGL-STADIUMPRO-5-1400W-HV

PRODUCT FEATURES & COMMON USE APPLICATIONS

- ✓ UL cUL
- ✓ Input voltage 277-480Vac
- ✓ No UV or IR in the beam
- ✓ Easy to install and operate
- ✓ Energy saving, long lifespan
- ✓ Instant start, NO flickering, NO humming
- ✓ Green and eco-friendly without mercury
- ✓ Output constant current lever can be adjusted through output cable with 0-10V.
- ✓ Stadium Fields
- ✓ Gymnasium
- ✓ Square plaza
- ✓ Shipyard, Airport, wharf
- ✓ High mast and Contour lighting, etc.

PRODUCT DIMENSIONS

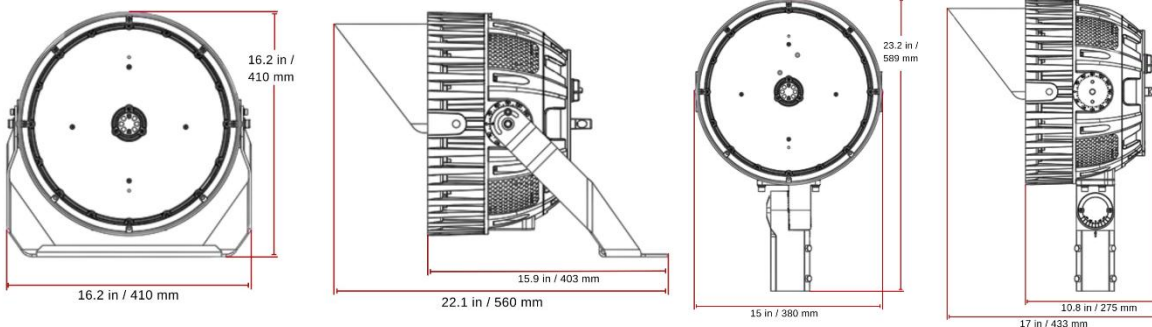

LEGENDARY USA SUPPORT



DLC
CERTIFIED

5 YEARS
WARRANTY

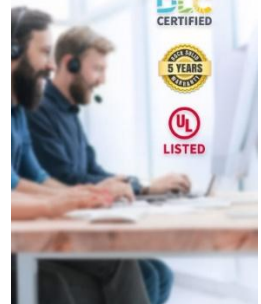

Rugged Grade Lighting
Industrial Grade Solutions



888-953-2476
sales@ruggedgrade.com



PRODUCT TECHNICAL SPECIFICATIONS

OPTICAL	Input Power (Tolerance: $\pm 10\%$)	1400W (Wattage adjustable 25%-100%)		
	Color Temperature	4000K	5000K	5700K
	Lumen (Tolerance: -10%)	210000 LM	211400 LM	212800 LM
	Efficacy (Tolerance: -3%)	150 LM/W	151 LM/W	152 LM/W
	CRI	>70		
	Color Consistency	< 6 Steps (or < 6 SDCM)		
	BUG	B5-U0-G3		
	Distribution Pattern	NEMA:4 (Optional:NEMA:4/NEMA:5)		
	Beam Angle (50%) (Tolerance: $\pm 15\%$)	20° (Optional:40°)		
ELECTRICAL	Input Voltage and Frequency	277-480VAC, 50/60Hz		
	PF (Tolerance: -3%)	≥ 0.9		
	THD (Tolerance: +5%)	$\leq 20\%$		
	Flicker Percent	<5%		
	Driver Brand	uPowerTek		
	Driver Model	uPowerTek		
	Driver Surge protection	BLD-700-C420-ENU*2PCS		
	Dimming	0-10V dimming standard		
	Optional Accessory	Sensor Receptacle+Photosensor /Sensor Receptacle+Short Cap, 10KV and Optional of 20KV for Surge-protective Device, Zhaga		
MATERIALS	LED Brand	Bridgelux		
	LED Type	SMD 3030		
	LED QTY	1200 PCS		
	Housing	Die-cast aluminum		
	Housing Color	Black, White, Bronze, or Customized		
	EPA	3.1 ft ²		
	Waterproof Rating	WET (IP65)		
	Operating Temperature	-40°C TO 45°C		
OTHERS	Storage Temperature	-40°C TO 80°C		
	Operating Humidity	20% - 90% RH		
	Storage Humidity	10% - 95% RH		
	Warranty	5 years warranty with 24/7 operating hours Luminaire lifetime at 25°C.		



PRODUCT IMAGES & ACTUAL INSTALLATIONS

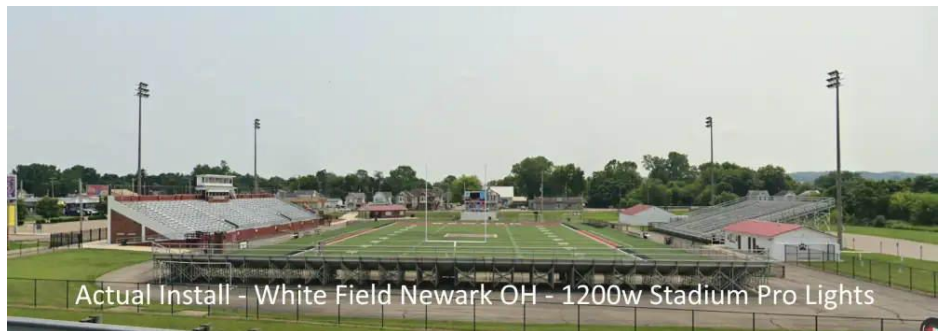
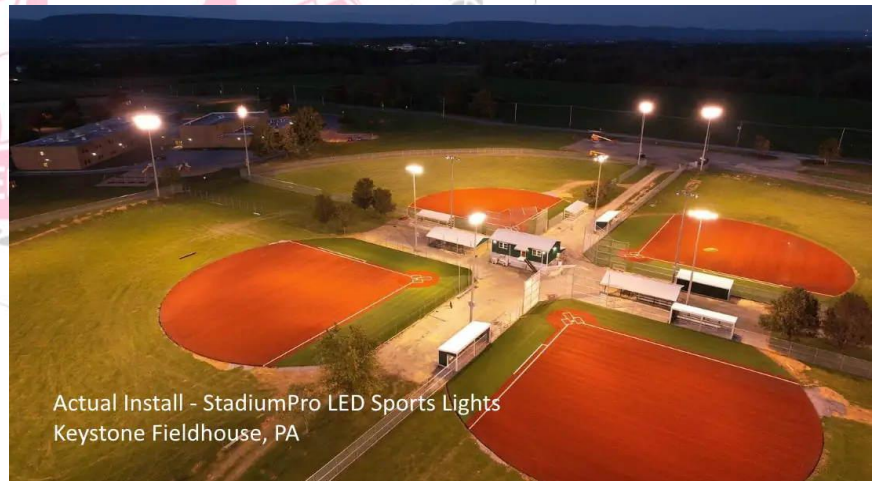
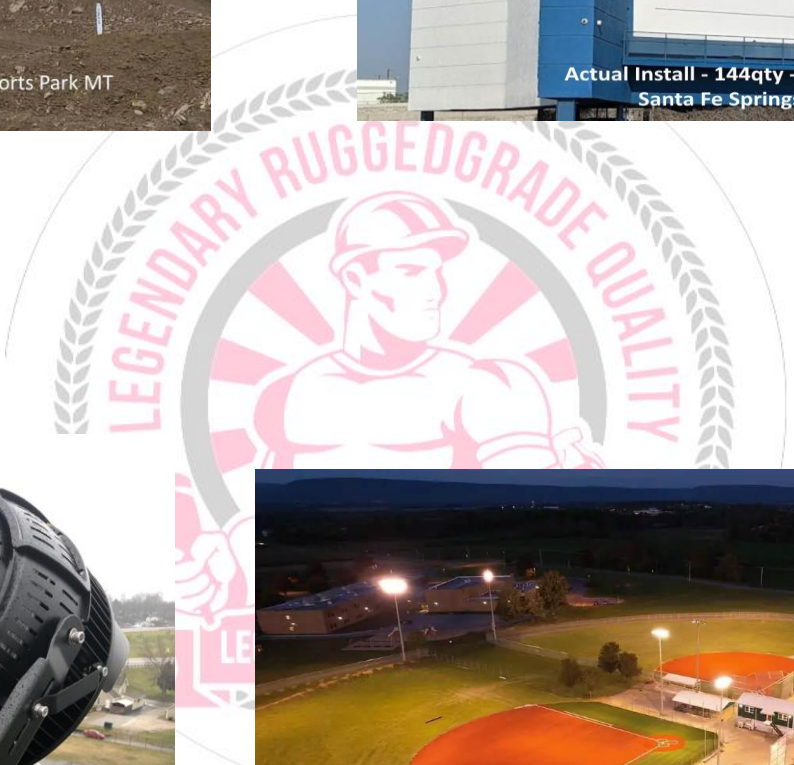
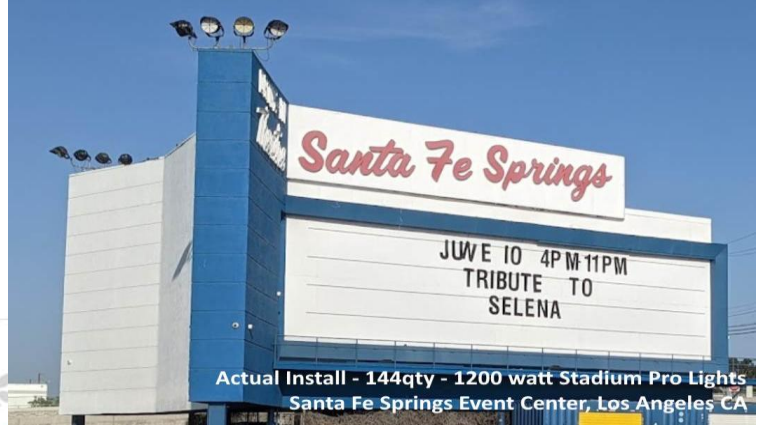

PHOTOMETRICS

Test:U:119.82V I:11.355A P:1351.8W PF:0.9935 Freq:60.01Hz
 Lamp Flux:201216x1 lm

NAME:	TYPE:	WEIGHT:
SPEC.:	DIM.:	SERIAL No.:
MFR.:	SUR.:	Shielding Angle:

DATA OF LAMP		PHOTOMETRIC DATA			
MODEL		Imax (cd)	687880	η street_up (%)	0.1
NOMINAL POWER (W)	1400	LOR (%)	100.0	η street_down (%)	50.5
RATED VOLTAGE (V)	120	TOTAL FLUX (lm)	201216	η house_up (%)	0.2
NOMINAL FLUX (lm)	201216	MAXIMUM @ (C, γ)	158,2.0	η house_down (%)	49.2
LAMPS INSIDE	1	η up (%)	0.3	76 FLASHAREA (m2)	
TEST VOLTAGE (V)	120	η down (%)	99.7	SLI	

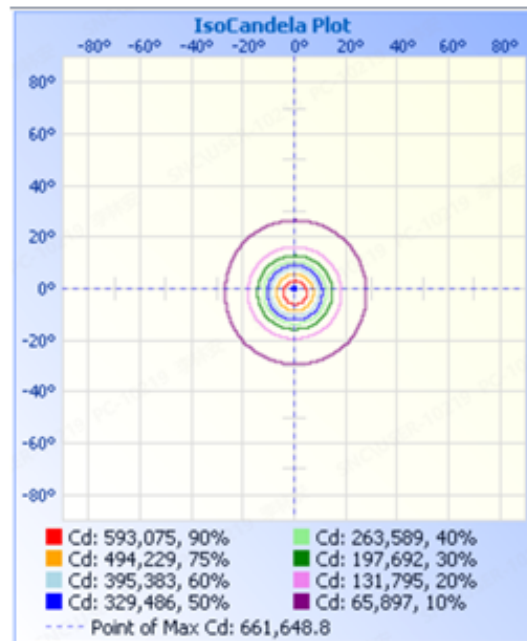
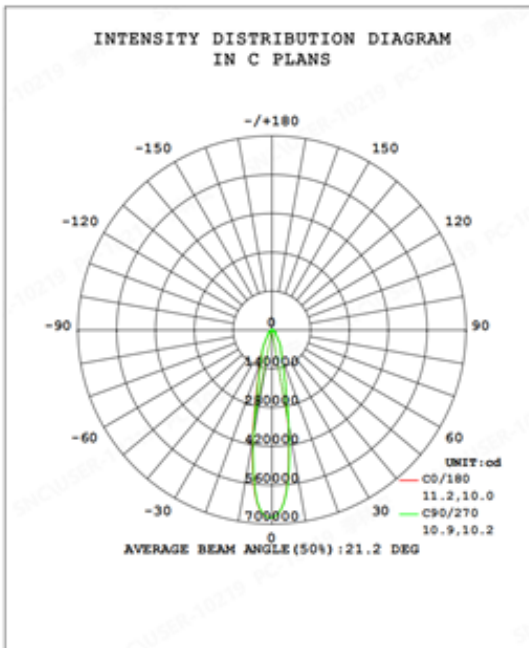



PRODUCT PACKAGING

Bracket Type	Carton Size	Qty / Carton	Net Weight / Carton	Gross Weight / Carton
FM	825*640*412mm [33.46*25.19*16.22inch]	1 PC	30.6KG [67.46LBS]	34.8KG [76.72LBS]
AM	825*640*412mm [33.46*25.19*16.22inch]	1 PC	33.2 KG [73.19LBS]	37.4 KG [82.45LBS]

Tolerance of Carton Size: ± 15 mm [± 0.59 inch], Tolerance of Weight: $\pm 10\%$.

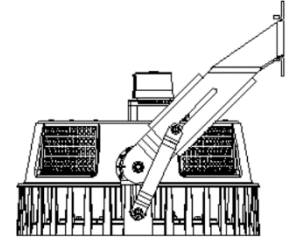
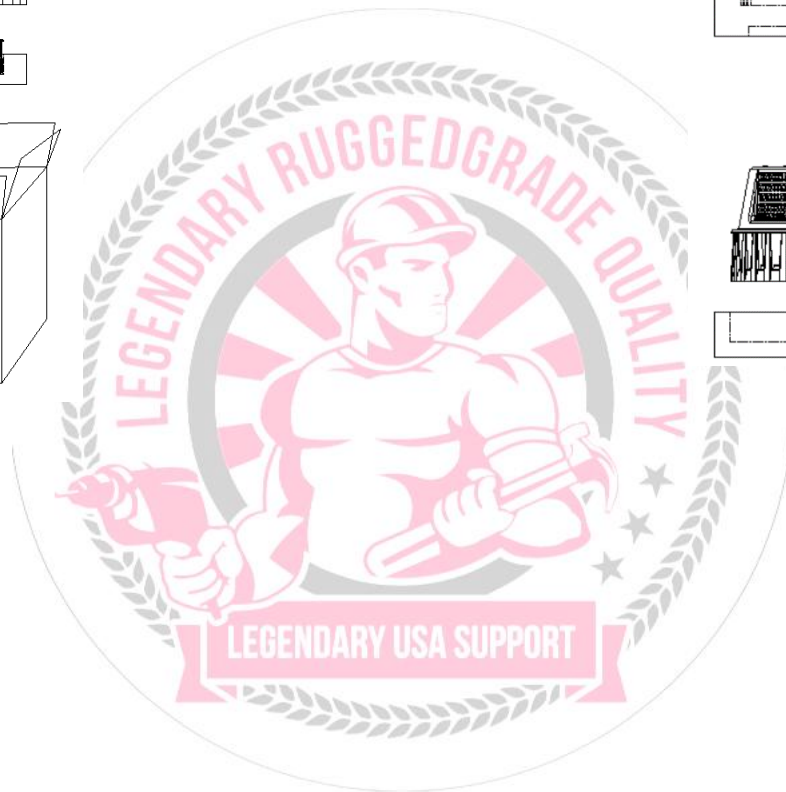
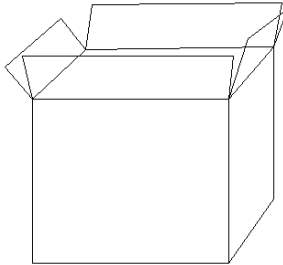
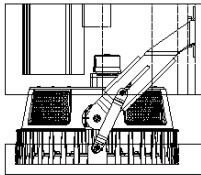



PRODUCT WARNINGS

- ⚡ Please turn off power before install or change assembly parts.
- ⚡ The input voltage and lamps should be matched, after connecting the power line.
- ⚡ Please make sure the wiring section is insulated.
- ⚡ Professionals must install and disassemble the lamps.
- ⚡ Surge is the number 1 cause of LED light failure. Outdoor lights must have surge at fixture, pole, and breaker.
- ⚡ Surge is the number 1 cause of LED light failure. Indoor lights must have surge at fixture and breaker.

PRODUCT TROUBLESHOOTING

Issue	Check points
Light Flickers	Check all wiring for disconnections, shorts and burnt wiring and connections. Confirm steady input voltage to the light fixture, fluctuating input voltage will harm the LED driver and can lead to premature failure. Lights with photocells can have photocell tag from ambient light or light reflecting at the sensor. Simply cover the photocell completely and see if flickering continues while the photocell is covered. Call Tech Support for help if none of the above solves the issue.
Light does not work at all.	Check all wiring for disconnections, shorts and burnt wiring and connections. Confirm steady input voltage to the light fixture, fluctuating input voltage will harm the LED driver and can lead to premature failure. If input voltage is not in the voltage range of the fixture, you will need to find the source of your input voltage issue. Call Tech Support for help if none of the above solves the issue.

For more technical information, install questions, troubleshooting help or warranty claims, we have a dedicated US Tech and Customer Support Team to help solve any issues you have and can be reached by email or phone. If you need help with any of our products, we are here for you so that you are never in the dark!

BETTER LIGHTS. BETTER SUPPORT.

