

PRODUCT DESCRIPTION

The StadiumPro Series reaches new heights with the Series IV! It boasts enhanced efficiency, delivering an impressive 150 Lumens per watt. Equipped with top-of-the-line uPowerTek Driver, it offers versatile mounting options and advanced optics. The Stadium Pro IV is UL Listed and DLC Premium 5.1 Certification this upcoming fall, solidifying its status as the Pinnacle of sports lighting!



DLC #: RGL-STADIUMPRO-4-500WT1PS3A1

PRODUCT FEATURES & COMMON USE APPLICATIONS

- ✓ UL cUL DLC-V5.1(Premium) certificate
- ✓ Input voltage 120-277Vac
- ✓ No UV or IR in the beam
- ✓ Easy to install and operate
- ✓ Energy saving, long lifespan
- ✓ Instant start, NO flickering, NO humming
- ✓ Green and eco-friendly without mercury
- ✓ Output constant current lever can be adjusted through output cable with 0-10V.
- ✓ Stadium Fields
- ✓ Gymnasium
- ✓ Square plaza
- ✓ Shipyard, Airport, wharf
- ✓ High mast and Contour lighting, etc.

PRODUCT DIMENSIONS

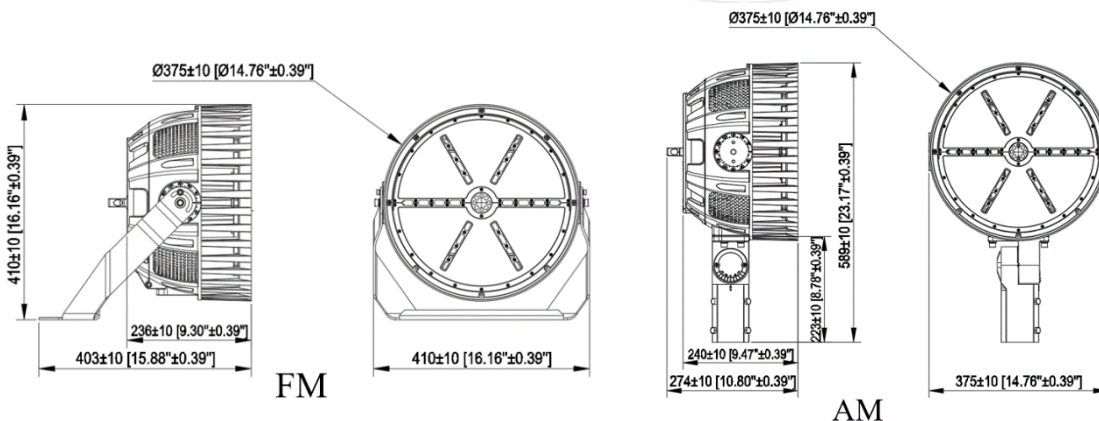

LEGENDARY USA SUPPORT



US based phone and online customer support



5 YEARS WARRANTY



LISTED

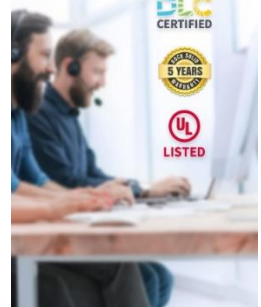

PRODUCT TECHNICAL SPECIFICATIONS

OPTICAL	Input Power (Tolerance: ±10%)	500W			
	Color Temperature	4000K	4500K	5000K	5700K
	Lumen (Tolerance: -10%)	76000 LM	76000 LM	78000 LM	78000 LM
	Efficacy (Tolerance: -3%)	152 LM/W	152 LM/W	155LM/W	155LM/W
	CRI	>70			
	Color Consistency	< 6 Steps (or < 6 SDCM)			
	BUG	B5-U0-G2			
	Distribution Pattern	NEMA:4			
Beam Angle (50%) (Tolerance: ±15%)	40° (Optional:20° /30° /60°)				
ELECTRICAL	Input Voltage and Frequency	120-277VAC, 50/60Hz			
	PF (Tolerance: -3%)	≥0.9			
	THD (Tolerance: +5%)	≤20%			
	Flicker Percent	<5%			
	Driver Brand	uPowerTek			
	Driver Model	BLD-240-C140-ENU-A00000*2PCS			
	Driver Surge protection	L/N-PE: 10kV, L-N:6kV			
	Dimming	0-10V dimming standard			
Optional Accessory	Integral Sensor Receptacle, Exterior Photocell				
MATERIALS	LED Brand	Bridgelux			
	LED Type	SMD3030			
	LED QTY	504 PCS			
	Housing	Die-cast aluminum			
	Housing Color	Black, White, Bronze, or Customized			
	Waterproof Rating	WET (IP65)			
	Operating Temperature	-40°C TO 45°C			
OTHERS	Storage Temperature	-40°C TO 80°C			
	Operating Humidity	20% - 90% RH			
	Storage Humidity	10% - 95% RH			
	Warranty	7 years warranty with 24/7 operating hours Luminaire lifetime at 25°C.			

PART NUMBER GUIDE

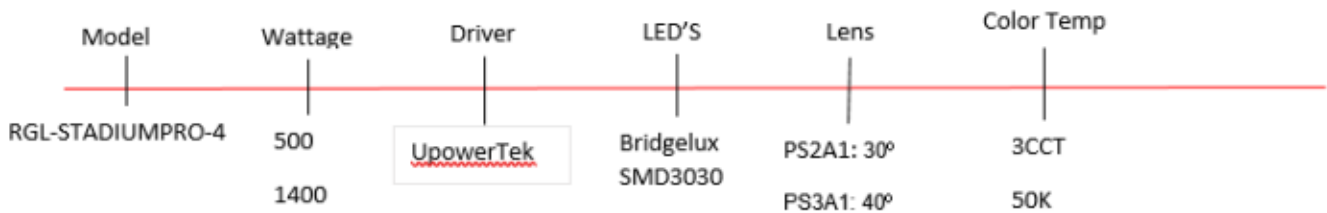

PRODUCT IMAGES & ACTUAL INSTALLATIONS

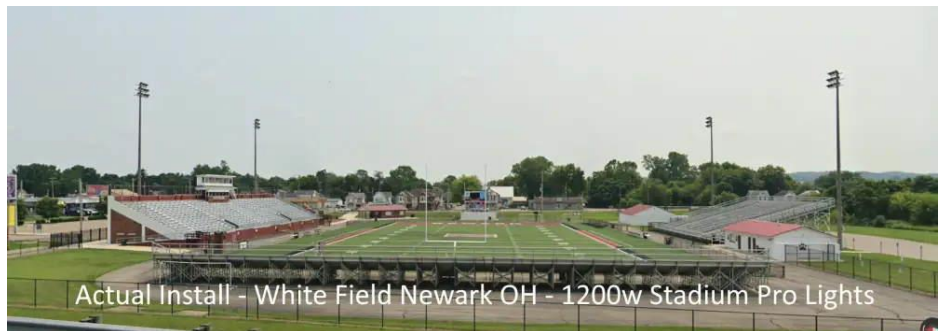
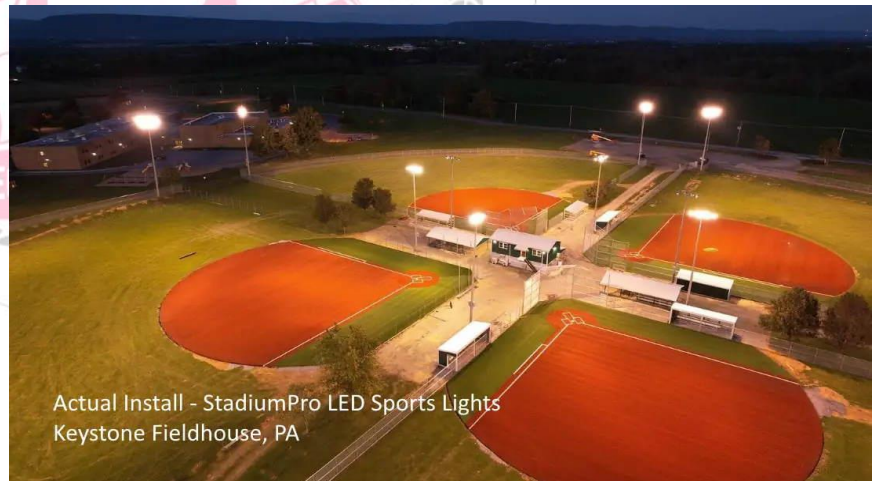
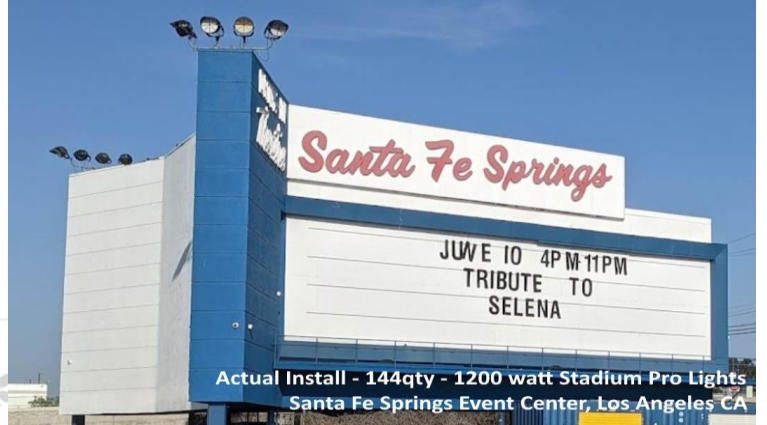



PHOTOMETRICS

Luminaire Property

Luminaire Manufacturer:
 Luminaire Category:
 Lamp Catalog:
 Number of Lamps:
 Luminous Length (mm):
 Luminous Height (mm):
 Current: 4.286 A
 Power Factor: 0.997

Luminaire Description:
 Lamp Description:
 Lumens per Lamp:
 Luminous Width (mm):
 Voltage: 120.0 V
 Power: 512.81 W

Photometric Results

IES Classification: Type I
 Total Rated Lamp Lumens: 77613.8 lm
 Efficiency: 100%
 Upward Ratio: 0%
 C0r0 Intensity: 161523.17 cd
 Pos of Max. Intensity: H0 V1
 Beam Angle(C0/C180,C90/C270,C45/C225,C135/315): 31.7, 30.1, 31.9, 30.6

Longitudinal Classification: Very Short
 Measurement Flux: 77613.8 lm
 Downward Ratio: 100%
 Luminaire Efficacy Rating (LER): 151.40
 Max. Intensity: 161744.82 cd

Luminous Intensity Distribution Curve

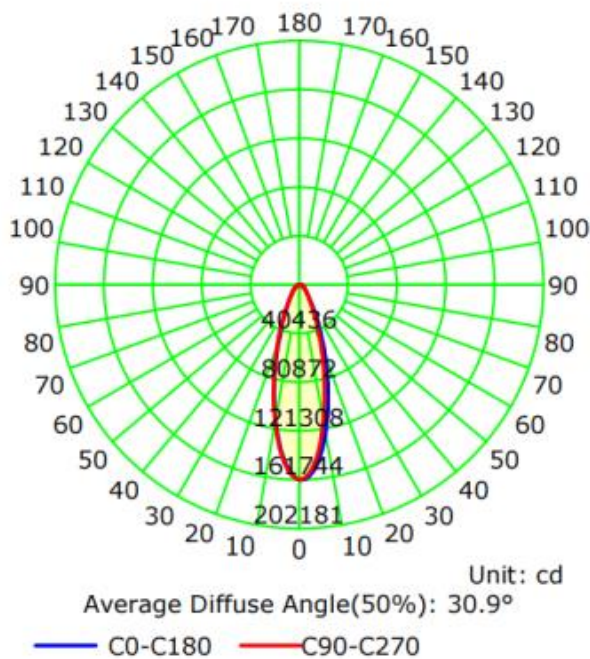

The Average Illuminance Effective Figure

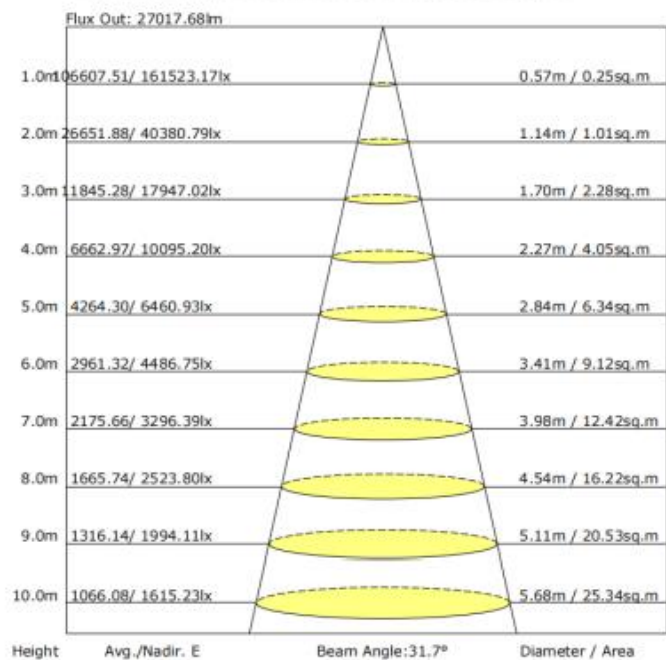

DLC SPECS



RGL-STADIUMPRO-4-500WT1PS3A1-acdeW50

Manufacturer: RuggedGrade
Brand: RuggedGrade

PRODUCT OVERVIEW

Classification	Premium
Primary Use	Architectural Flood and Spot Luminaires
Reported Input Wattage	511.9 W
Reported Light Output	78731 lm
Reported CCT	5000 K
Reported CRI (Ra)	73
Product ID	S-L7S8T4
DLC Family Code	VWAKM
Listing Status	Listed
Date Qualified	2023-11-06

PRODUCT INFORMATION

Qualified Product List	Solid State Lighting
Technical Requirements Version	5.1
Product ID	S-L7S8T4
Manufacturer	RuggedGrade
Brand	RuggedGrade
Model Number	RGL-STADIUMPRO-4-500WT1PS3A1-acdeW50
Parent	No
Classification	Premium

PRODUCT CATEGORIZATION

[VIEW DETAILS](#)

CONTROL FEATURES

[VIEW DETAILS](#)

REPORTED PHOTOMETRIC PERFORMANCE

Reported Light Output	78731 lm
Reported Efficacy (AC)	153.8 lm/W
Reported CCT	5000 K
Reported CRI (Ra)	73
Reported R9	-32
Reported IES Rf	75
Reported IES Rg	93
Reported IES Rcs,h1	-17

REPORTED ELECTRICAL PERFORMANCE

Reported Input Wattage	511.9 W
Reported Total Harmonic Distortion	15 %
Reported Power Factor	0.9
Reported Minimum Input Wattage	125 W
Reported Maximum Input Wattage	511.9
Reported Default Input Wattage	511.9 W
Voltage Range	120-277 V



PRODUCT PACKAGING

Bracket Type	Carton Size	Qty / Carton	Net Weight / Carton	Gross Weight / Carton
FM	505*490*485 MM [19.9*19.3*19.1 inch]	1 PC	14.82 KG [32.60 LBS]	17.5 KG [38.50 LBS]

*Tolerance of Carton Size: ±15 MM, Tolerance of Weight: ±10%.

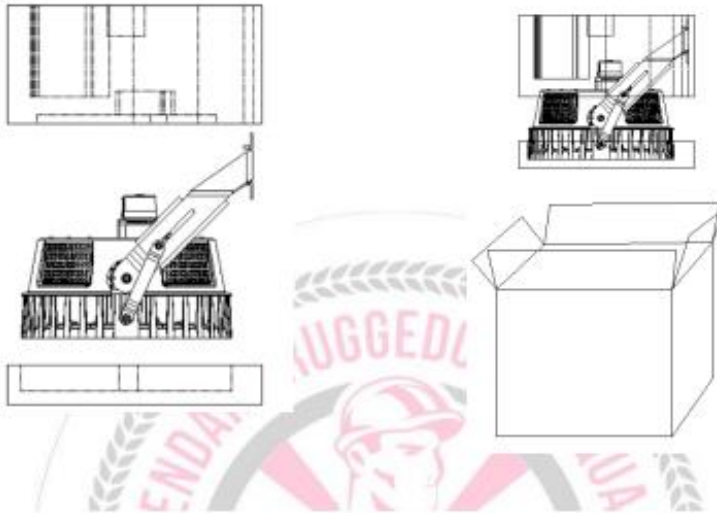

PRODUCT WARNINGS

- ⚡ Please turn off power before install or change assembly parts.
- ⚡ The input voltage and lamps should be matched, after connecting the power line.
- ⚡ Please make sure the wiring section is insulated.
- ⚡ Professionals must install and disassemble the lamps.
- ⚡ Surge is the number 1 cause of LED light failure. Outdoor lights must have surge at fixture, pole, and breaker.
- ⚡ Surge is the number 1 cause of LED light failure. Indoor lights must have surge at fixture and breaker.

PRODUCT TROUBLESHOOTING

Issue	Check points
Light Flickers	Check all wiring for disconnections, shorts and burnt wiring and connections. Confirm steady input voltage to the light fixture, fluctuating input voltage will harm the LED driver and can lead to premature failure. Lights with photocells can have photocell tag from ambient light or light reflecting at the sensor. Simply cover the photocell completely and see if flickering continues while the photocell is covered. Call Tech Support for help if none of the above solves the issue.
Light does not work at all.	Check all wiring for disconnections, shorts and burnt wiring and connections. Confirm steady input voltage to the light fixture, fluctuating input voltage will harm the LED driver and can lead to premature failure. If input voltage is not in the voltage range of the fixture, you will need to find the source of your input voltage issue. Call Tech Support for help if none of the above solves the issue.

For more technical information, install questions, troubleshooting help or warranty claims, we have a dedicated US Tech and Customer Support Team to help solve any issues you have and can be reached by email or phone. If you need help with any of our products, we are here for you so that you are never in the dark!

BETTER LIGHTS. BETTER SUPPORT.

