

## PRODUCT DESCRIPTION

The new fully tunable ALTUS series canopy light is now with a sleek & smaller design sporting advanced and improved standard features, including precision optics and more available options.



## PART #:

RGL-ALTUS-75WL1B1T2A1

## PRODUCT FEATURES & COMMON USE APPLICATIONS

- DLC5.1 and UL cUL certificate.
- Lumileds or Samsung Chip, high CRI.
- Input voltage 120-277VAC.
- Output constant current lever can be adjusted through output cable with 0-10V.
- No UV or IR in the beam.
- Easy to install and operate.
- Energy saving, long lifespan.
- Light is soft and uniform, safe to eyes.
- Instant start, NO flickering, NO humming.
- Green and eco-friendly without mercury.
- Warehouse, factory, and workshops.
- Highway toll station and gas station.
- Exhibition hall.
- Gymnasium and supermarkets, etc

## PRODUCT DIMENSIONS

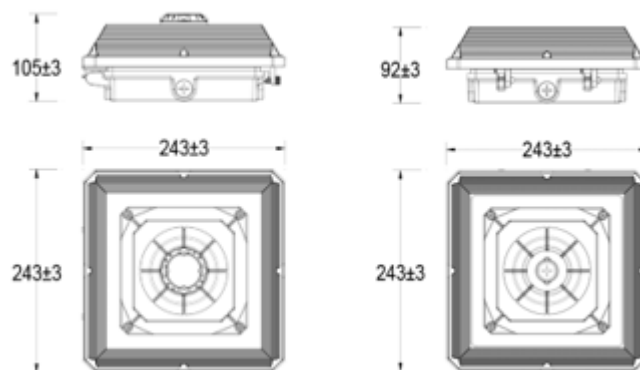

## LEGENDARY USA SUPPORT



US based phone and online customer support



888-933-2470

sales@ruggedgrade.com





## PRODUCT TECHNICAL SPECIFICATIONS

<b>OPTICAL</b>	Input Power (Tolerance : ±10%)	75W (Wattage Tunable:75W 60W 40W )		
	Color Temperature	3000K	4000K	5000K
	Lumen (Tolerance : -10%)	9000-9750LM	10500-11250	9750-10500LM
	Efficacy (Tolerance : -3%)	120-130LM/W	140-150LM/W	130-140LM/W
	CRI	>80		
	Color Consistency	<7 Steps (or <7 SDCM)		
	Diffuser Type	PC Lens		
	Beam Angle (50%) (Tolerance :	190 Degree		
	Input Voltage and Frequency	120-347VAC, 50/60Hz		
<b>ELECTRICAL</b>	PF (Tolerance : -3%)	≥0.9		
	THD (Tolerance : +5%)	≤20%		
	Flicker Percent	<5%		
	Driver Brand	Fahold		
	Driver Model	FD-75T-054B		
	Driver Surge protection	L/N-PE: 6kV, L-N: 4kV		
	Dimming	0-10V dimming standard		
	Optional Accessory	Motion Sensor, Surge-protective Device		
	LED Brand	Lumileds		
<b>MATERIALS</b>	LED Type	SMD2835		
	LED QTY	280*2PCS		
	Housing	Die-cast aluminum		
	Housing Color	White, or Customized		
	Waterproof Rating	WET (IP65)		
	Operating Temperature	-40°C TO 45°C		
<b>OTHERS</b>	Operating Humidity	-40% - 90% RH		
	Storage Humidity	10% - 90% RH		
	Warranty	5 years warranty with 24/7 operating hours Luminaire lifetime		

## PRODUCT MOUNTS & ACCESSORIES









**RuggedGrade**

# INDOOR/OUTDOOR

Replaces 250-400 watt Metal Halide or HPS lights, 1000W incandescent or 250W CFL

-  **IP65 RATED**  
DUST AND WATERPROOF
-  **FOR INDOOR AND OUTDOOR USE**  
IN ANY WEATHER CONDITIONS
-  **POLYCARBONATE FRESNEL LENS**  
REDUCED GLARE WITH HIGH TRANSPARENCY
-  **ALUMINUM HOUSING**  
OPTIMAL HEAT DISSIPATION



**US based**  
phone and online  
customer support



**5 YEARS**  
WARRANTY

**DLC PREMIUM RATED**



**UL LISTED**





## PHOTOMETRICS & DLC PRODUCT SPEC

### LIGHT DISTRIBUTION TESTING PARAMETERS

#### Luminaire Property

Luminaire Manufacturer:  
 Luminaire Category:  
 Lamp Catalog:  
 Number of Lamps:  
 Luminous Length (mm):  
 Luminous Height (mm):  
 Current: 0.613 A  
 Power Factor: 0.999

Luminaire Description:  
 Lamp Description:  
 Lumens per Lamp:  
 Luminous Width (mm):  
 Voltage: 120.0 V  
 Power: 73.54 W

#### Photometric Results

IES Classification: Type I  
 Total Rated Lamp Lumens: 9462.5 lm  
 Efficiency: 100%  
 Upward Ratio: 10%  
 C0r0 Intensity: 1184.42 cd  
 Pos of Max. Intensity: H225 V39

Longitudinal Classification: Very Short  
 Measurement Flux: 9462.5 lm  
 Downward Ratio: 90%  
 Luminaire Efficacy Rating (LER): 128.72  
 Max. Intensity: 1677.66 cd

Luminous Intensity Distribution Curve

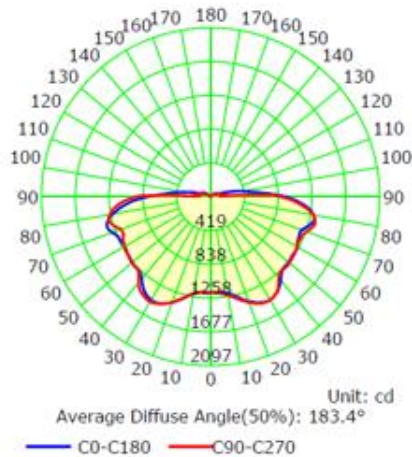

The Average Illuminance Effective Figure

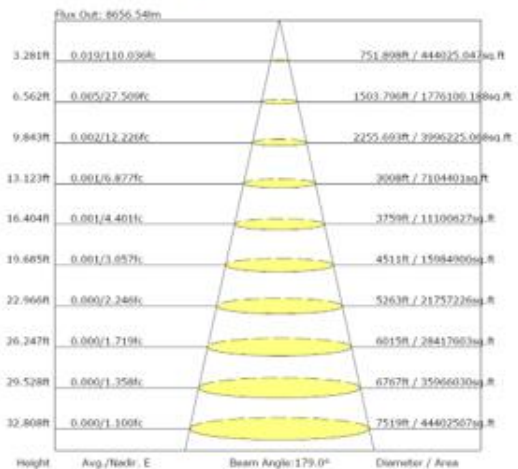

Product ID: S-BMJPAO

X



## RGL-ALTUS-75WBSP1DC1-a[M;P;Blank]cWe

Manufacturer: RuggedGrade  
Brand: RuggedGrade

### PRODUCT OVERVIEW

Classification	Premium
Primary Use	Parking Garage Luminaires
Reported Input Wattage	73.54 W
Reported Light Output	9462.5 lm
Reported CCT	3000 K
Reported CRI (Ra)	83
Product ID	S-BMJPAO
DLC Family Code	SLFAJ
Listing Status	Listed
Date Qualified	2023-03-06

### PRODUCT INFORMATION

Qualified Product List	Solid State Lighting
Technical Requirements Version	5.1
Product ID	S-BMJPAO
Manufacturer	RuggedGrade
Brand	RuggedGrade
Model Number	RGL-ALTUS-75WBSP1DC1-a[M;P;Blank]cWe
Parent	No
Classification	Premium

### PRODUCT CATEGORIZATION

[VIEW DETAILS](#)

### CONTROL FEATURES

[VIEW DETAILS](#)

### REPORTED PHOTOMETRIC PERFORMANCE

Reported Light Output	9462.5 lm
Reported Efficacy (AC)	128.67 lm/W
Reported CCT	3000 K
Reported CRI (Ra)	83
Reported R9	10
Reported IES Rf	85
Reported IES Rg	97
Reported IES Rcs, h1	-11

### REPORTED ELECTRICAL PERFORMANCE

Reported Input Wattage	73.54 W
Reported Total Harmonic Distortion	20 %
Reported Power Factor	0.9
Reported Minimum Input Wattage	40 W
Reported Maximum Input Wattage	73.54
Reported Default Input Wattage	73.54 W
Voltage Range	120-347 V



## PRODUCT PACKAGING

	Size	Qty / Carton	Net Weight / Carton	Gross Weight / Carton
Inner box	280*130*280 mm	1 PCS	2.2 KG	2.3 KG
Outer box	535*295*580 mm	8 PCS	17.6 KG	19.6 KG



\*Tolerance of Carton Size:  $\pm 15$  MM, Tolerance of Weight:  $\pm 10\%$ .

PRODUCT WARNINGS

- ⚡ Please turn off power before install or change assembly parts.
- ⚡ The input voltage and lamps should be matched, after connecting the power line.
- ⚡ Please make sure the wiring section is insulated.
- ⚡ Professionals must install and disassemble the lamps.
- ⚡ Surge is the number 1 cause of LED light failure. Outdoor lights must have surge at fixture, pole, and breaker.
- ⚡ Surge is the number 1 cause of LED light failure. Indoor lights must have surge at fixture and breaker.

PRODUCT TROUBLESHOOTING

Issue	Check points
Light Flickers	Check all wiring for disconnections, shorts and burnt wiring and connections. Confirm steady input voltage to the light fixture, fluctuating input voltage will harm the LED driver and can lead to premature failure. Lights with photocells can have photocell tag from ambient light or light reflecting at the sensor. Simply cover the photocell completely and see if flickering continues while the photocell is covered. Call Tech Support for help if none of the above solves the issue.
Light does not work at all.	Check all wiring for disconnections, shorts and burnt wiring and connections. Confirm steady input voltage to the light fixture, fluctuating input voltage will harm the LED driver and can lead to premature failure. If input voltage is not in the voltage range of the fixture, you will need to find the source of your input voltage issue. Call Tech Support for help if none of the above solves the issue.

For more technical information, install questions, troubleshooting help or warranty claims, we have a dedicated US Tech and Customer Support Team to help solve any issues you have and can be reached by email or phone. If you need help with any of our products, we are here for you so that you are never in the dark!

**BETTER LIGHTS.  
BETTER SUPPORT.**

