

PRODUCT DESCRIPTION

THE NEW BARN LIGHT IS A NEW PRIVATE DESIGN LED SOLAR STREET LIGHT, WITH A SLIM DESIGN AND A HIGHER CONVERSION EFFICIENCY. MONO-CRYSTALLINE PHOTOVOLTAIC SOLAR PANEL THAT CAUSE A 190LM/W EFFICIENCY ALLOWS US TO MEET NEW AND BETTER STANDARDS.



Part #: RGL-LIRA-2-30W

PRODUCT FEATURES & COMMON USE APPLICATIONS

- ✓ Nice design with lighter weight, easier installation
- ✓ Shatterproof Rating: IK10
- ✓ The controller has dimming and timer options
- ✓ Battery life is longer with an 10 hour charge
- ✓ Easy to install and operate
- ✓ Energy saving, long lifespan
- ✓ Instant start, NO flickering, NO humming
- ✓ Green and eco-friendly without mercury
- ✓ Adjustable Beam Angle
- ✓ Street Lighting
- ✓ Outdoor landscaping light
- ✓ Building, The Hotel.
- ✓ Parking Lot

PRODUCT DIMENSIONS

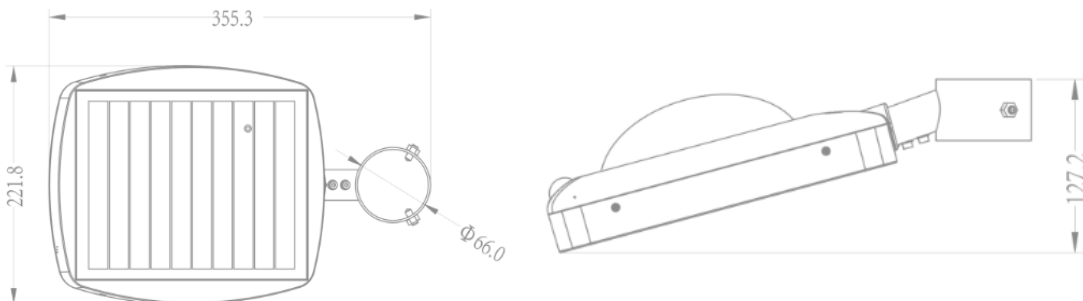

LEGENDARY USA SUPPORT



US based phone and online customer support

DLC CERTIFIED

5 YEARS WARRANTY

UL LISTED

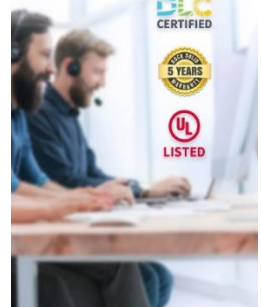

PRODUCT TECHNICAL SPECIFICATIONS

OPTICAL	Input Power (Tolerance: ±10%)	30W
	Color Temperature	4000K
	Efficacy (Tolerance: -3%)	190lm/W
	CRI	Ra70
	Solar Panel Specs	Polycrystalline , 5W
	Battery Specs	18650 NCM
	Beam Angle (50%) (Tolerance: ±15%)	120
	Battery Capacity	3.7V38.48WH 2.6AH/PC
	Charge Time	10 Hours
ELECTRICAL	PF (Tolerance: -3%)	≥0.95
	THD (Tolerance: +5%)	≤20%
	Flicker Percent	<70%
	Driver Brand	RG
	Driver Model	RG-30W-120v
	Driver Surge protection	L/N-PE: 2.5kV, L-N:2.5kV
	Dimming	Motion Sensor and remote control
	Optional Accessory	None
	LED Brand	Lumileds
MATERIALS	LED Type	2835
	LED QTY	60 PCS
	Housing	Aluminum Alloy
	Housing Color	Silver
	Waterproof Rating	Wet(IP65)
	Operating Temperature	-20°C ~ 60°C / -4°F~ 140°F
	Storage Temperature	-20°C ~ 60°C / -4°F~ 140°F
OTHERS	Operating Humidity	20% - 90% RH
	Storage Humidity	10% - 95% RH
	Warranty	5 years warranty with 24/7 operating hours Luminaire lifetime at 25°C.
	Charge Time	10Hrs

PRODUCT ACCESORIES



- **ON/OFF**: Turn on and off
- **M1/M2/M3**: Change lighting mode
- **T**: Timer.
 1. Press one time: 100% brightness 10 minutes
 2. Fast press 2 times within 2 seconds: 100% brightness 20 minutes
 After timer finished, light will work in the last lighting mode you set.
- 3. Cancel Timer: Long press T



PRODUCT IMAGES AND FEATURES

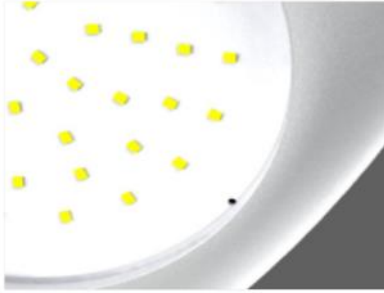

High lumen LEDs 190lm/W
Large Lamp Shade Φ 115mm



PIR : >5m, 120° Anti-interference
black Fresnel lens /
IR Receiver / Indicator



All in one alloy design



Polycrystalline
Solar Charging Efficiency :>19%

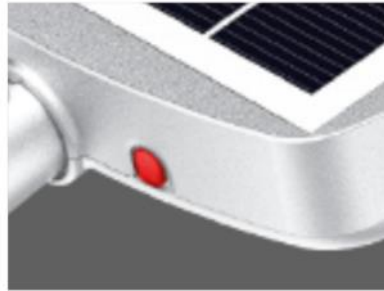

Switch



Bracket

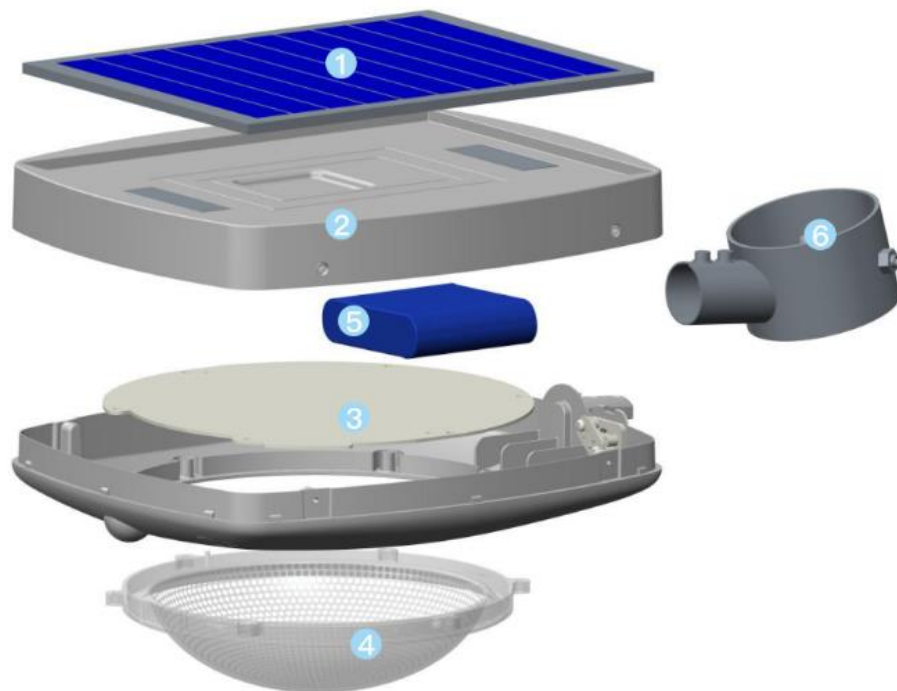

Solar Panel



Product Shell



Led Plate



Optical Lens



Battery Pack



Bracket



PHOTOMETRICS

Road Simulated Diagram

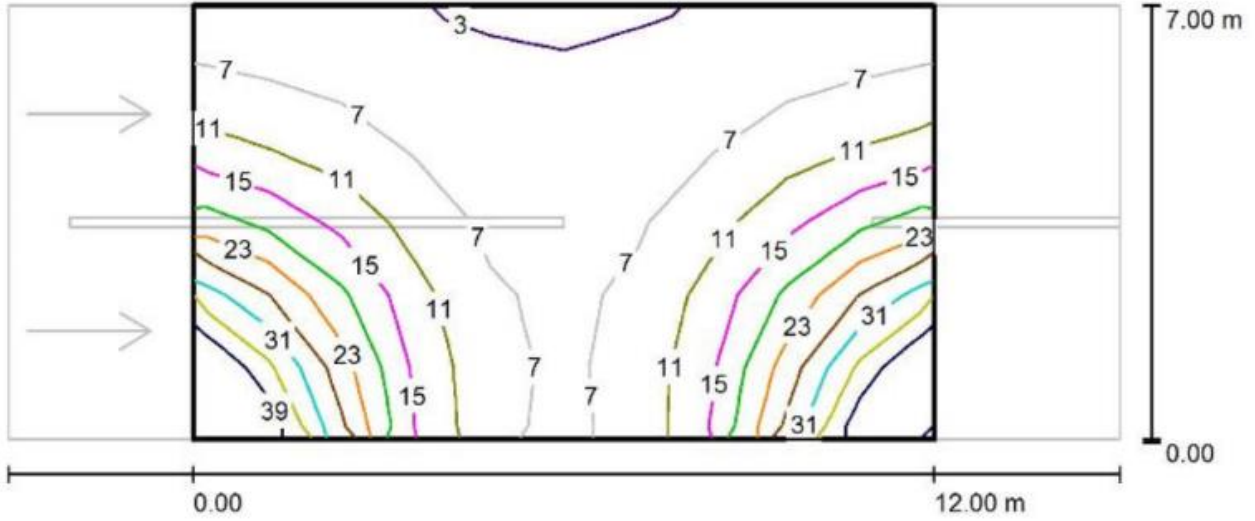

Illumination Curve

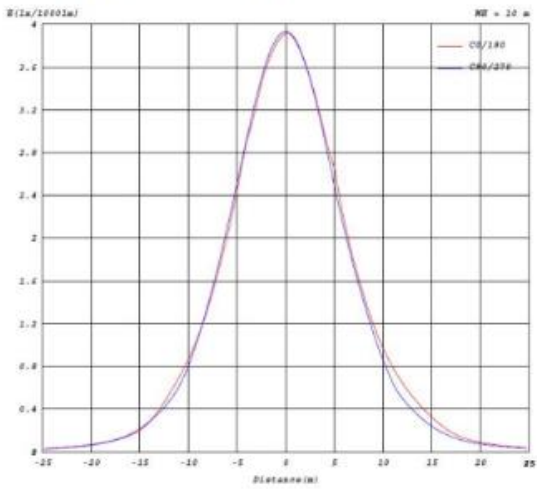

Luminance Distribution

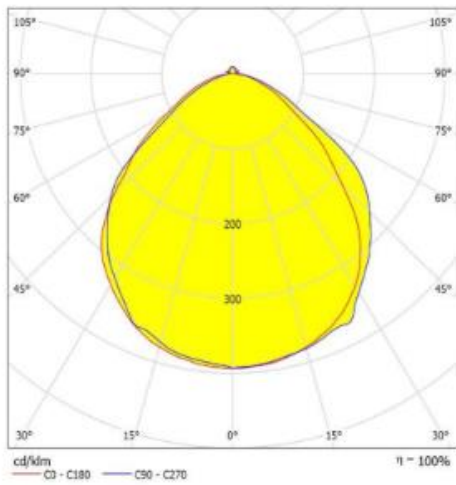

PACKAGING

PACKING METHOD	PCS/CTN	QTY(PCS)	CTN QTY	CARTON SIZE(MM)	N.W.(KG)	G.W.(KG)
INNER BOX	1	1	1	40*11.2*24.5	1.71	1.94
CARTON	4	4	1	46.5*42.0*26.5	7.87	8.86

Net weight and gross weight are for reference only

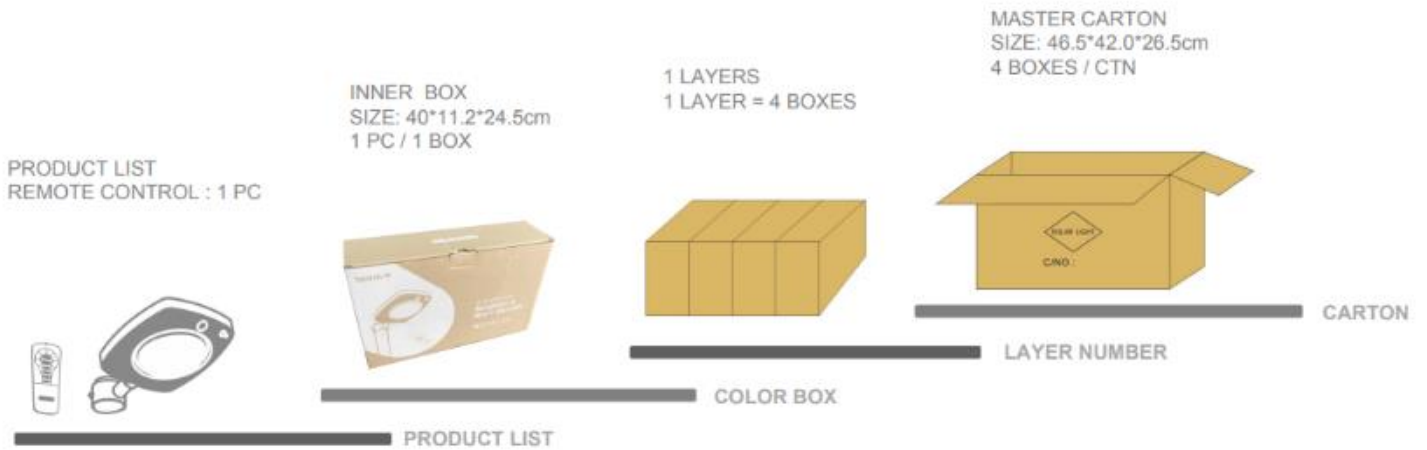



INSTALLATION

- 1 Dig a hole according to the size of the foundation cage, put the foundation cage into the hole and fix it with concrete C20.

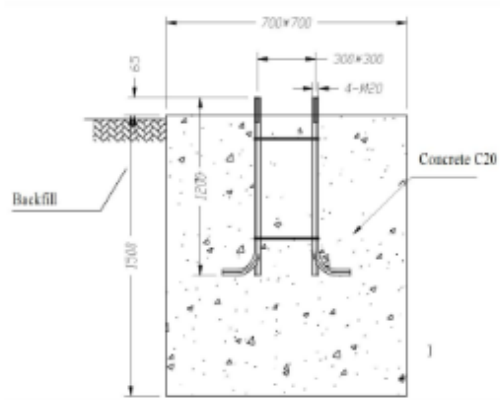

- 2 Use the supplied screws to fix the lamp on the post .

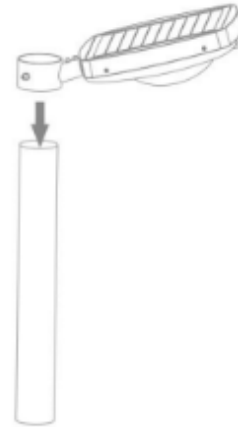

- 3 Lift the lamp pole by the person or machine, align the bottom flange of the lamp pole with the foundation cage, and then fix the lamp pole with screws.

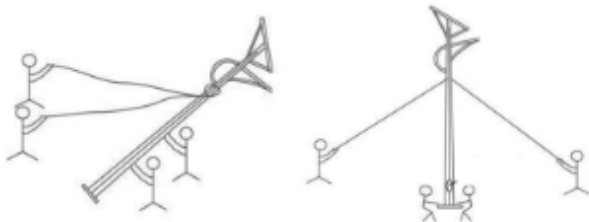

USER GUIDE

Special Note:

1. Do not install the lamp against the sun, under the shadow or between two buildings which height above the lamp. Otherwise, it will lead to insufficient absorption of sunlight and insufficient brightness and time;
2. Do not use the lamp in the environment temperature above 45°C or below 0°C, otherwise will cause the rapid attenuation of the battery and affect the battery life, even damage;
3. Do not use the non-standard installation accessories to install the lamp, otherwise any accident is caused will be borne by the installer;
4. Choose the suitable lighting mode according to local sunshine.
5. Please charge the product every 3 months to ensure the activity of the lithium battery;
6. If you storage the product over one year, please do fully charge and discharge inspection and make sure the battery is in good condition. Otherwise, it is forbidden to use!

Warning:

1. Keep the device away from fire and oil to avoid any fire or explosion;
2. No one except professional technicians should attempt to disassemble the light in order to avoid damaging the light;
3. It is strictly forbidden to disassemble the battery for personal use;
4. If the lamp doesn't get charge for 3 days, the battery maybe out of power, you have to charge it under bright sunlight;
5. In order to ensure that the lamp works in an ideal state for a long time, please clean the solar panel regularly according to the local dust conditions, our suggestion is one time at least half a year;
6. long-term static storage the product over one year will cause the inside battery damage or even leakage. If the battery is leaking, it will cause the battery to spontaneously ignite.

Main Parts

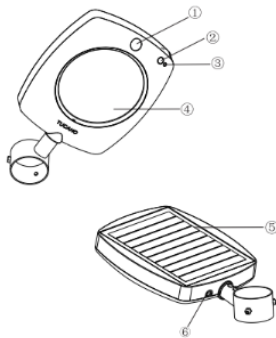

- ① PIR
- ② remote control receiver
- ③ Indicator
- ④ Lampshade
- ⑤ Solar panel
- ⑥ Switch

Electrical Characteristics:

Solar panel: Polycrystalline
 Rechargeable Battery: Li-ion Battery
 Material: Aluminum alloy & PC

Rugged Grade Lighting
 Industrial Grade Solutions

Solar Street Light

How to install the device?

Use the supplied screws to fix the lamp on the pole

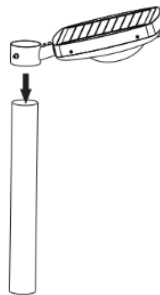

Keep the solar panel towards the sun to ensure that it can be charged well, and in this way the solar panel can charge built-in Li-ion battery effectively.



User Manual

Solar Street Light

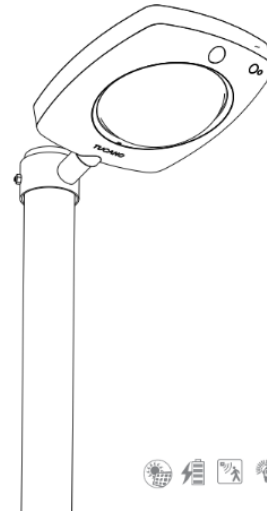

Working process instructions

1. Switch: Press 1.5S for ON/OFF
 2. Short Press the Button to Switch Lighting Modes: M1(Red)/M2(Orange)/M3(Green). After 30s the led indicator says battery power left, not lighting mode.
 3. Power Indicator:
 Green: Power ≥ 80%
 Orange: 80% ≥ Power ≥ 50%
 Red: Power < 50%
- Mode 1(red): 120LM + PIR 3000LM
 Mode 2(orange): 240LM + PIR 3000LM
 Mode 3(green): 5Hrs 400LM + 80LM with PIR to dawn

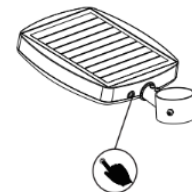

Remote controller

- ON/OFF: Turn on and off
 - M1/M2/M3: Change lighting mode
 - T: Timer.
1. Press one time: 100% brightness 10 minutes
 2. Fast press 2 times within 2 seconds: 100% brightness 20 minutes
 After timer finished, light will work in the last lighting mode you set.
 3. Cancel Timer: Long press T



888-953-2476
 sales@ruggedgrade.com

PRODUCT WARNINGS

- ⚡ Please turn off power before install or change assembly parts.
- ⚡ The input voltage and lamps should be matched, after connecting the power line.
- ⚡ Please make sure the wiring section is insulated.
- ⚡ Professionals must install and disassemble the lamps.
- ⚡ Surge is the number 1 cause of LED light failure. Outdoor lights must have surge at fixture, pole, and breaker.
- ⚡ Surge is the number 1 cause of LED light failure. Indoor lights must have surge at fixture and breaker.

PRODUCT TROUBLESHOOTING

Issue	Check points
Light Flickers	Check all wiring for disconnections, shorts and burnt wiring and connections. Confirm steady input voltage to the light fixture, fluctuating input voltage will harm the LED driver and can lead to premature failure. Lights with photocells can have photocell tag from ambient light or light reflecting at the sensor. Simply cover the photocell completely and see if flickering continues while the photocell is covered. Call Tech Support for help if none of the above solves the issue.
Light does not work at all.	Check all wiring for disconnections, shorts and burnt wiring and connections. Confirm steady input voltage to the light fixture, fluctuating input voltage will harm the LED driver and can lead to premature failure. If input voltage is not in the voltage range of the fixture, you will need to find the source of your input voltage issue. Call Tech Support for help if none of the above solves the issue.

For more technical information, install questions, troubleshooting help or warranty claims, we have a dedicated US Tech and Customer Support Team to help solve any issues you have and can be reached by email or phone. If you need help with any of our products, we are here for you so that you are never in the dark!



**BETTER LIGHTS.
BETTER SUPPORT.**



CERTIFIED



LISTED



LEGENDARY RUGGEDGRADE DUTY



**US based
phone and online
customer support**



**ROCK SOLID
5 YEARS
WARRANTY**