

PRODUCT DESCRIPTION

The Top Rated NextGen Series Gets Better! The NextGen III Series has 140+ Lumens per Watt, bigger VP driver and is DLC 5.1 Premium Rated! New pop open Compartment for fast access and optional easy twist in Motion Sensor that can be programmed by a remote



DLC #:

RGL-NEXTGEN3-100JT3A1

PRODUCT FEATURES & COMMON USE APPLICATIONS

- UL cUL DLC-V5.0(Premium) certificate.
- Bridgelux Chip, high CRI.
- Input voltage 120-277VAC.
- Output constant current level can be adjusted through output cable with 0-10V.
- No UV or IR in the beam.
- Easy to install and operate.
- Energy saving, long lifespan.
- Light is soft and uniform, safe to eyes.
- Instant start, NO flickering, NO humming.
- Green and eco-friendly without mercury
- Outdoor basketball court, tennis court.
- Badminton court, the football field.
- The school playground, stadium.
- Community leisure entertainment plaza, road lamp etc.

PRODUCT DIMENSIONS

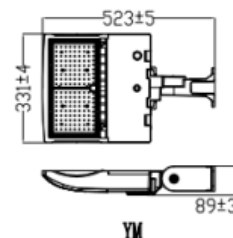
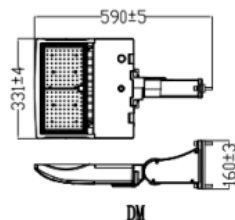
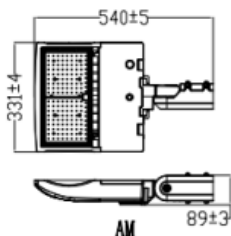
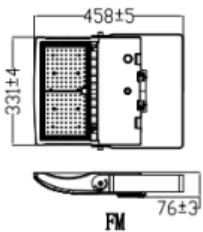

LEGENDARY USA SUPPORT



US based phone and online customer support





PRODUCT TECHNICAL SPECIFICATIONS

OPTICAL	Input Power (Tolerance : ±10%)	100W			
	Color Temperature	3000K	4000K	5000K	5700K
	Lumen (Tolerance : -10%)	14000LM	14500LM	14500LM	14500LM
	Efficacy (Tolerance : -3%)	140LM/W	140LM/W	140LM/W	140LM/W
	CRI	>70			
	Color Consistency	<6 Steps (or <6 SDCM)			
	BUG	B3-U0-G3			
	Diffuser Type	Type III			
Beam Angle (50%) (Tolerance :	155*120 Degree				
ELECTRICAL	Input Voltage and Frequency	120-277VAC, 50/60Hz			
	PF (Tolerance : -3%)	≥0.9			
	THD (Tolerance : +5%)	≤20%			
	Flicker Percent	<5%			
	Driver Brand	Sosen VP series			
	Driver Model	Sosen VP series			
	Driver Surge protection	L/N-PE: 10kV, L-N: 6kV			
	Dimming	0-10V dimming standard			
	Optional Accessory	Photocontrol, Surge-protective Device, Motion Sensor			
	MATERIALS	LED Brand	Bridgelux		
LED Type		SMD3030			
LED QTY		154PCS			
Housing		Die-cast aluminum			
Housing Color		Brown, Black, or Customized			
Waterproof Rating		WET (IP65)			
OTHERS	Operating Temperature	Without Motion Sensor: -40°C TO 45°C			
	Storage Temperature	-40°C TO 80°C			
	Operating Humidity	20% - 90% RH			
	Storage Humidity	10% - 95% RH			
	Warranty	5 years warranty with 24/7 operating hours Luminaire lifetime			

PRODUCT MOUNTS & ACCESSORIES



AM



DM



YM



FM



PRODUCT IMAGES & ACTUAL INSTALLATIONS



NEXTGEN III
THE BEST TENNIS COURT LIGHT ON THE MARKET



-  **ULTRA-LOW GLARE**
-  **EXTREME UNIFORMITY FOR GREAT PLAY**
-  **150,000 HOURS**
-  **7-YEAR WARRANTY**





PHOTOMETRICS & DLC PRODUCT SPEC

Luminaire Property

Luminaire Manufacturer:
 Luminaire Category:
 Lamp Catalog:
 Number of Lamps:
 Luminous Length (mm):
 Luminous Height (mm):
 Current: 0.835 A
 Power Factor: 1.000

Luminaire Description:
 Lamp Description:
 Lumens per Lamp:
 Luminous Width (mm):
 Voltage: 120.0 V
 Power: 100.33 W

Photometric Results

IES Classification: Type IV
 Total Rated Lamp Lumens: 13772.9 lm
 Efficiency: 100%
 Upward Ratio: 0%
 C0r0 Intensity: 3092.97 cd
 Pos of Max. Intensity: H22.5 V71

Longitudinal Classification: Medium
 Measurement Flux: 13772.9 lm
 Downward Ratio: 100%
 Luminaire Efficacy Rating (LER): 137.33
 Max. Intensity: 4604.82 cd

Luminous Intensity Distribution Curve

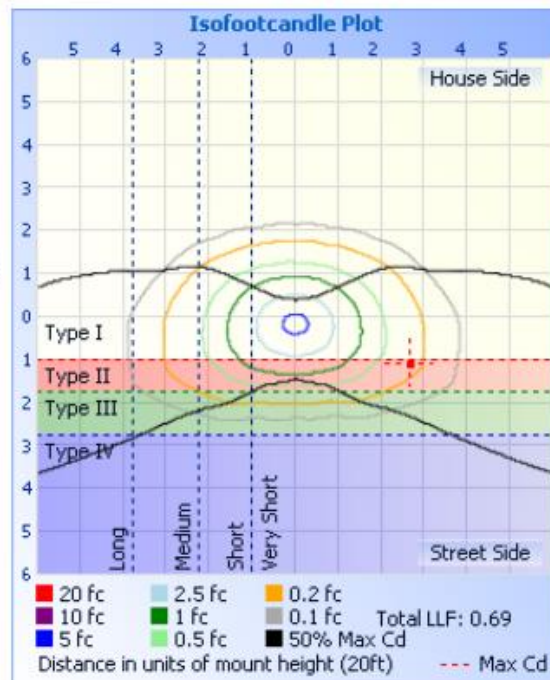
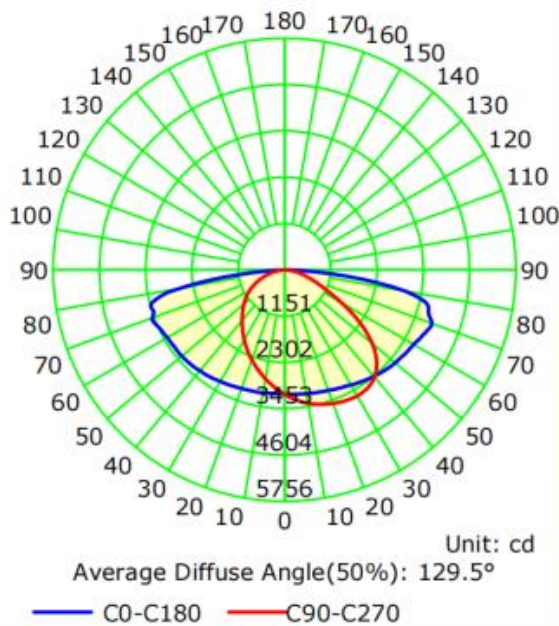

Product ID: PL3J68FHJV4U



RGL-NEXTGEN3-100JT3A1-abc[10SP;20SP]50f

Manufacturer: RuggedGrade
Brand: RuggedGrade

PRODUCT OVERVIEW

Classification	Premium
Primary Use	Architectural Flood and Spot Luminaires
Reported Input Wattage	100.21 W
Reported Light Output	14379.4 lm
Reported CCT	5000 K
Reported CRI (Ra)	70
Product ID	PL3J68FHJV4U
DLC Family Code	EMWAF
Listing Status	Listed
Date Qualified	2021-08-17

PRODUCT INFORMATION

Qualified Product List	Solid State Lighting
Technical Requirements Version	5.1
Product ID	PL3J68FHJV4U
Manufacturer	RuggedGrade
Brand	RuggedGrade
Model Number	RGL-NEXTGEN3-100JT3A1-abc[10SP;20SP]50f
Parent	No
Classification	Premium

PRODUCT CATEGORIZATION

[VIEW DETAILS](#)

PRODUCT CAPABILITIES

[VIEW DETAILS](#)

REPORTED PHOTOMETRIC PERFORMANCE

Reported Light Output	14379.4 lm
Reported Efficacy (AC)	143.49 lm/W
Reported CCT	5000 K
Reported CRI (Ra)	70
Reported R9	-28
Reported IES Rf	76
Reported IES Rg	95
Reported IES Rcs,h1	-16

REPORTED ELECTRICAL PERFORMANCE

[VIEW DETAILS](#)



PRODUCT PACKAGING

Bracket Type	Carton Size	Qty / Carton	Net Weight / Carton	Gross Weight / Carton
AM	690*380*155MM	1 PC	5.7 KG	6.45KG
DM	690*380*155MM	1 PC	6.16KG	6.91KG
YM	690*380*155MM	1 PC	5.6KG	6.35KG
A&D	690*380*155MM	1 PC	6.51KG	7.26KG
FM	645*405*155MM	1 PC	5.22KG	5.92KG

Tolerance of Carton Size: ± 15 MM, Tolerance of Weight: $\pm 10\%$.

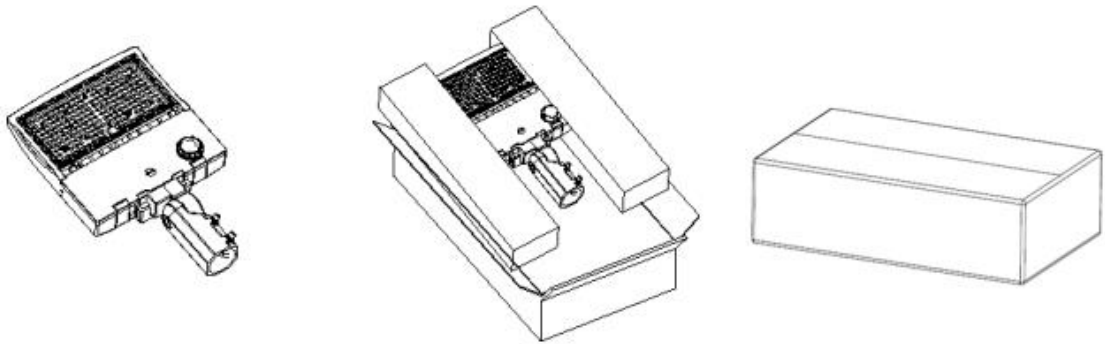

PRODUCT WARNINGS

- ⚡ Please turn off power before install or change assembly parts.
- ⚡ The input voltage and lamps should be matched, after connecting the power line.
- ⚡ Please make sure the wiring section is insulated.
- ⚡ Professionals must install and disassemble the lamps.
- ⚡ Surge is the number 1 cause of LED light failure. Outdoor lights must have surge at fixture, pole, and breaker.
- ⚡ Surge is the number 1 cause of LED light failure. Indoor lights must have surge at fixture and breaker.

PRODUCT TROUBLESHOOTING

Issue	Check points
Light Flickers	Check all wiring for disconnections, shorts and burnt wiring and connections. Confirm steady input voltage to the light fixture, fluctuating input voltage will harm the LED driver and can lead to premature failure. Lights with photocells can have photocell tag from ambient light or light reflecting at the sensor. Simply cover the photocell completely and see if flickering continues while the photocell is covered. Call Tech Support for help if none of the above solves the issue.
Light does not work at all.	Check all wiring for disconnections, shorts and burnt wiring and connections. Confirm steady input voltage to the light fixture, fluctuating input voltage will harm the LED driver and can lead to premature failure. If input voltage is not in the voltage range of the fixture, you will need to find the source of your input voltage issue. Call Tech Support for help if none of the above solves the issue.

For more technical information, install questions, troubleshooting help or warranty claims, we have a dedicated US Tech and Customer Support Team to help solve any issues you have and can be reached by email or phone. If you need help with any of our products, we are here for you so that you are never in the dark!

BETTER LIGHTS. BETTER SUPPORT.

